

integra

FELTLINE CEILING SYSTEMS

 **integra**[®]

 **echoshape**





Our vision, which has consistently proved itself in the field of product quality and diversity with its R&D activities, comes to life with Integra products. Integra develops design solutions to realize the ceiling design that best suits the aesthetic requirements. For more than 25 years, Integra has been producing metal ceiling; it offers all the installation options and product variety required by the global building industry. Integra carries out its production and sales within its own structure together with the rapidly developing metal processing technologies.

Integra not only sells products; it is involved in all stages of the project, from design phase to after-sales services, and contributes to projects by providing appropriate design solutions when needed. Integra also provides innovative design support for the project in order to empower and support the imagination of designers.

Dreams come true with Integra's privilege;

Integra, ceiling your dreams...



INDEX

6	01 CEILINGS
36	02 GROOVED
46	03 SHAPED
56	04 ACOUSTIC PARTITIONS
68	05 PYRAMID TILES
74	06 TECHNICAL INFORMATION



Chapter

01

 **integra**[®]
FELTLINE CEILING SYSTEMS

Ceilings

- Baffle Beam
- Baffle Gradual
- Symi Grid
- Kea Grid
- Hydra Grid
- Feltline Corridor
- Diagonal
- Barcode
- Modular Cubes
- Grooved
- Baffle Wave
- Galaxy
- Baffle
- Feltline

INFORMATION

Baffle is vertically installed unframed units. It is available in different sizes and a wide range of colors. Two hanging methods: free hanging of each of the baffles or using a connector profile that maintains a uniform hanging. Customized sizes are available.

PROPERTIES



Acoustic Absorption

Our products poses a superb acoustic quality: NRC=0.4-0.95 in a variety of implementation applications that enable the creation of an ideal living environment, pleasant and of high quality, well suited for office spaces, halls, education structures and entertainment places.

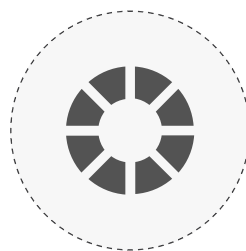

Color Fading

Assessment of colour fastness according to EN 1587 Assessed against the grey scale ISO 105-A02.

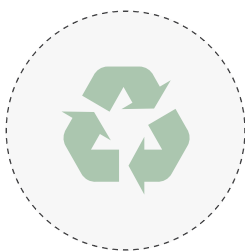

Recycled

The boards are made of 100% polyester PET, of which about 70% is recycled from drinking bottles.



Sustainability

Our PET Felt products contains post-consumer PET, does not contain any lead or tin, nor does it emit any (VOC) off gasses. It is recyclable and durable material, suitable for every environment.



Fire Reaction

Our products are manufactured in Israel according to the European fireproofing standard EN13501-I and American ASTM84 Class A.



Cleaning

Can be simply done using a damp cloth and vacuum cleaner.



SPECIFICATION

PRODUCT	Max Length (mm)	Height (mm)	Thickness (mm)
Baffle Beam	2780	100	9
		160	
		260	
		560	

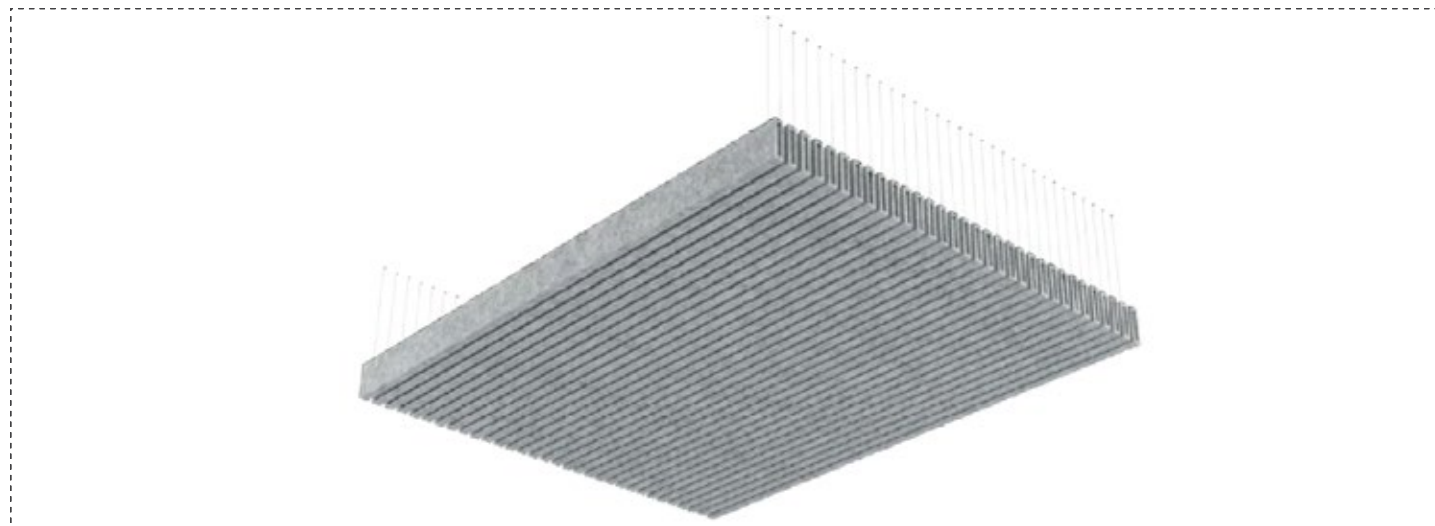

COLOR PALETTE

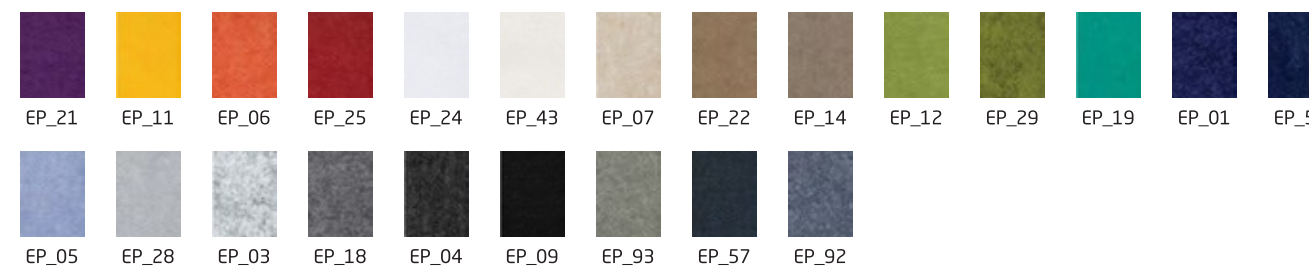

WOOD COLLECTION

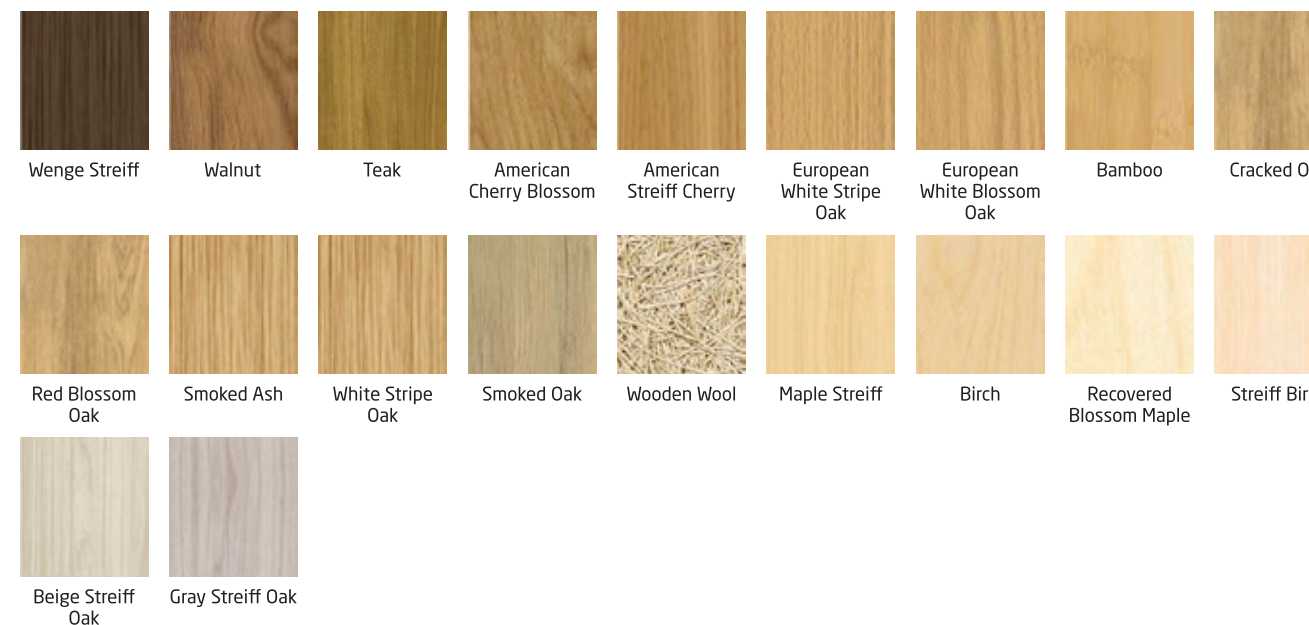

INFORMATION

Baffle is vertically installed unframed units. It is available in different sizes and a wide range of colors. Two hanging methods: free hanging of each of the baffles or using a connector profile that maintains a uniform hanging. Customized sizes are available.

PROPERTIES



Acoustic Absorption

Our products poses a superb acoustic quality: NRC=0.4-0.95 in a variety of implementation applications that enable the creation of an ideal living environment, pleasant and of high quality, well suited for office spaces, halls, education structures and entertainment places.

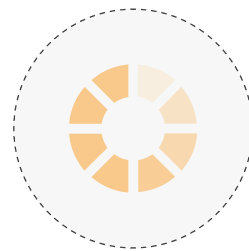

Color Fading

Assessment of colour fastness according to EN 1587 Assessed against the grey scale ISO 105-A02.

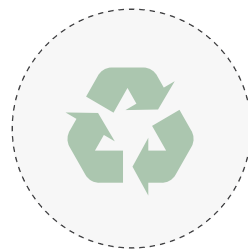

Recycled

The boards are made of 100% polyester PET, of which about 70% is recycled from drinking bottles.



Sustainability

Our PET Felt products contains post-consumer PET, does not contain any lead or tin, nor does it emit any (VOC) off gasses. It is recyclable and durable material, suitable for every environment.



Fire Reaction

Our products are manufactured in Israel according to the European fireproofing standard EN13501-I and American ASTM84 Class A.



Cleaning

Can be simply done using a damp cloth and vacuum cleaner.



SPECIFICATION

PRODUCT	Max Length (mm)	Height (mm)	Thickness (mm)
Baffle Gradual	2780	150-250	12
		100-300	24
		200-400	

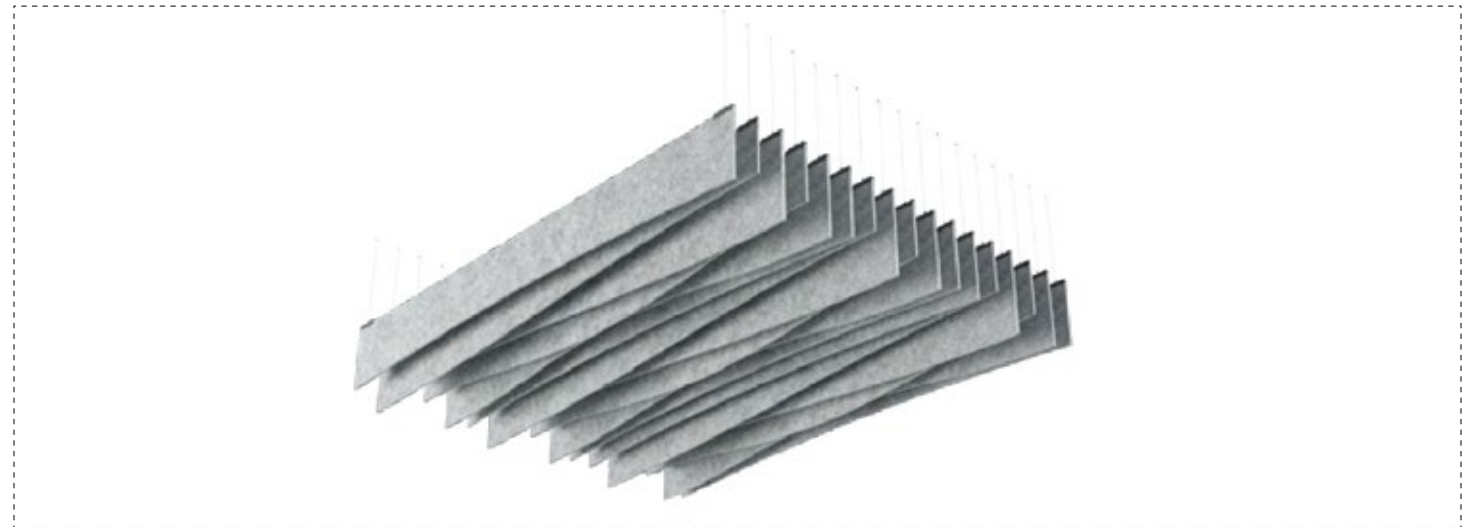

COLOR PALETTE

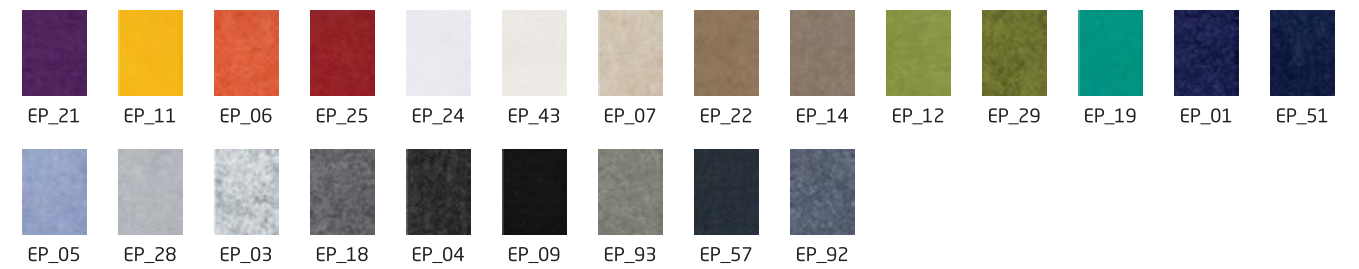

WOOD COLLECTION

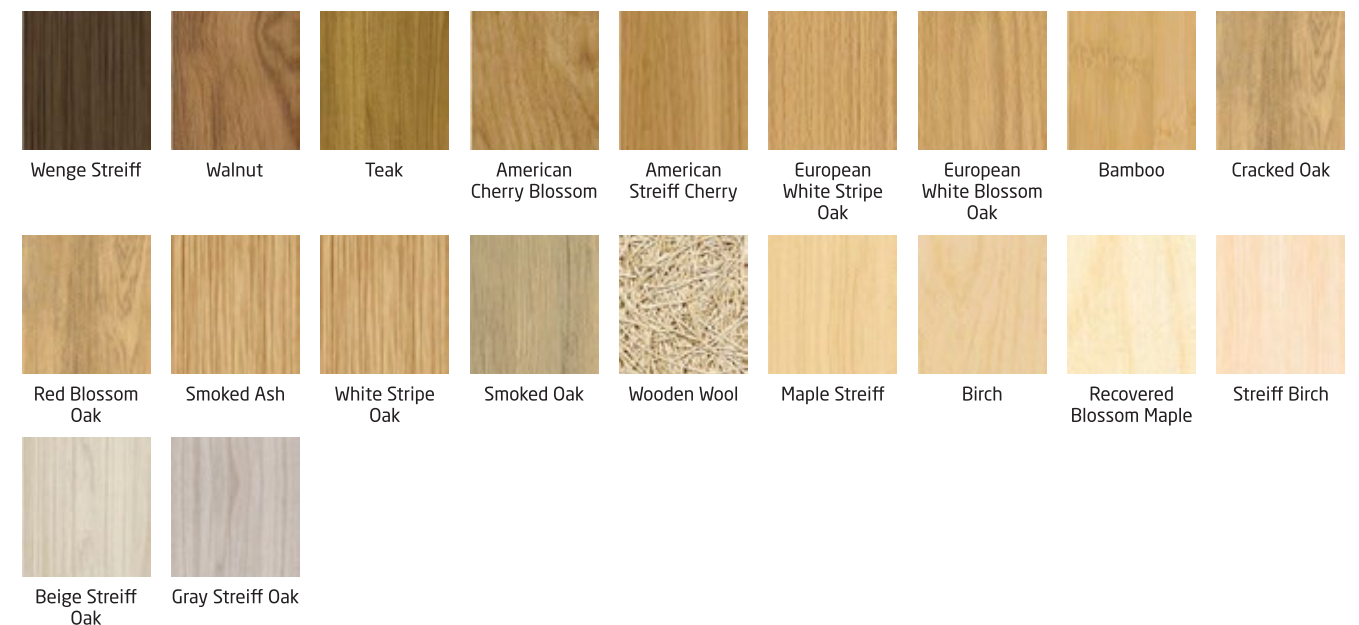

INFORMATION

A floating open cells island - is a colorful element in the space, hanging from the ceiling, adding design and acoustics to the space. A selection of shades from an existing fan of colors. Can be painted in any desired shade.

PROPERTIES



Acoustic Absorption

Our products poses a superb acoustic quality: NRC=0.4-0.95 in a variety of implementation applications that enable the creation of an ideal living environment, pleasant and of high quality, well suited for office spaces, halls, education structures and entertainment places.

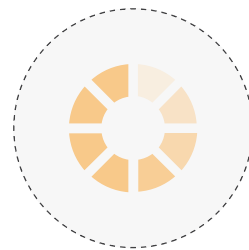

Color Fading

Assessment of colour fastness according to EN 1587 Assessed against the grey scale ISO 105-A02.

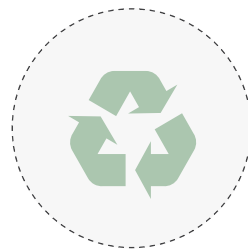

Recycled

The boards are made of 100% polyester PET, of which about 70% is recycled from drinking bottles.



Sustainability

Our PET Felt product contains post-consumer PET, does not contain any lead or tin, nor does it emit any (VOC) off gasses. It is recyclable and durable material, suitable for every environment.



Fire Reaction

Our products are manufactured in Israel according to the European fireproofing standard EN13501-I and American ASTM84 Class A.



Cleaning

Can be simply done using a damp cloth and vacuum cleaner.



SPECIFICATION

PRODUCT	Cell Size (mm)	Height (mm)	Thickness (mm)
Symi Grid	200x200	100	12
	300x300	150	24
	400x400	200	
	600x600	300	

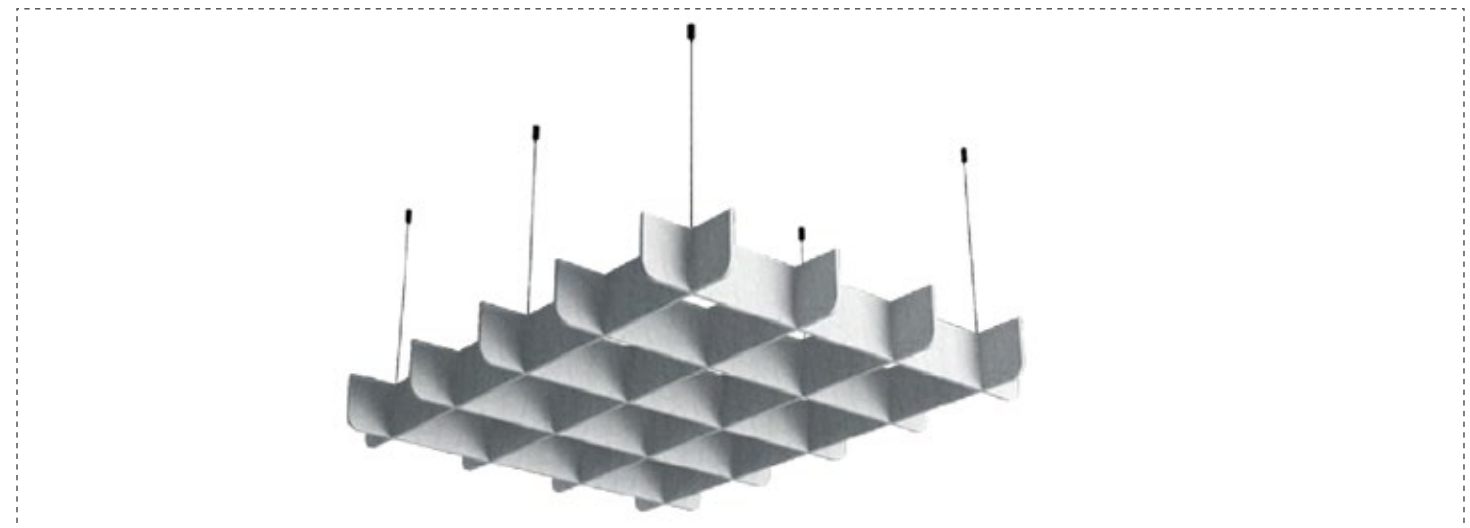

COLOR PALETTE

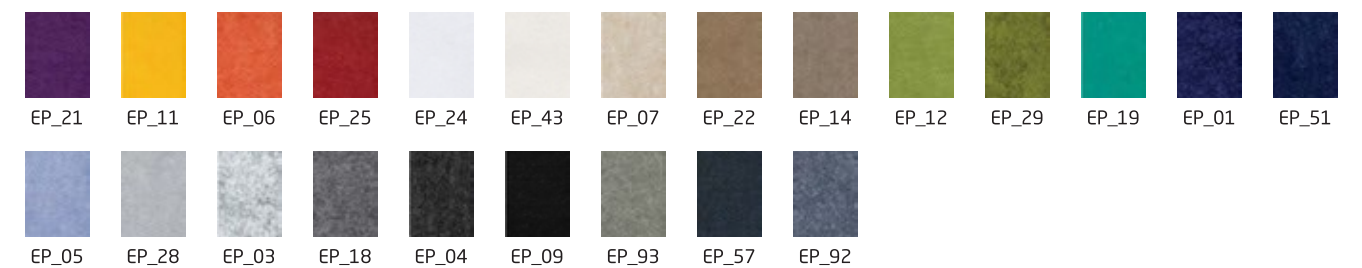

WOOD COLLECTION

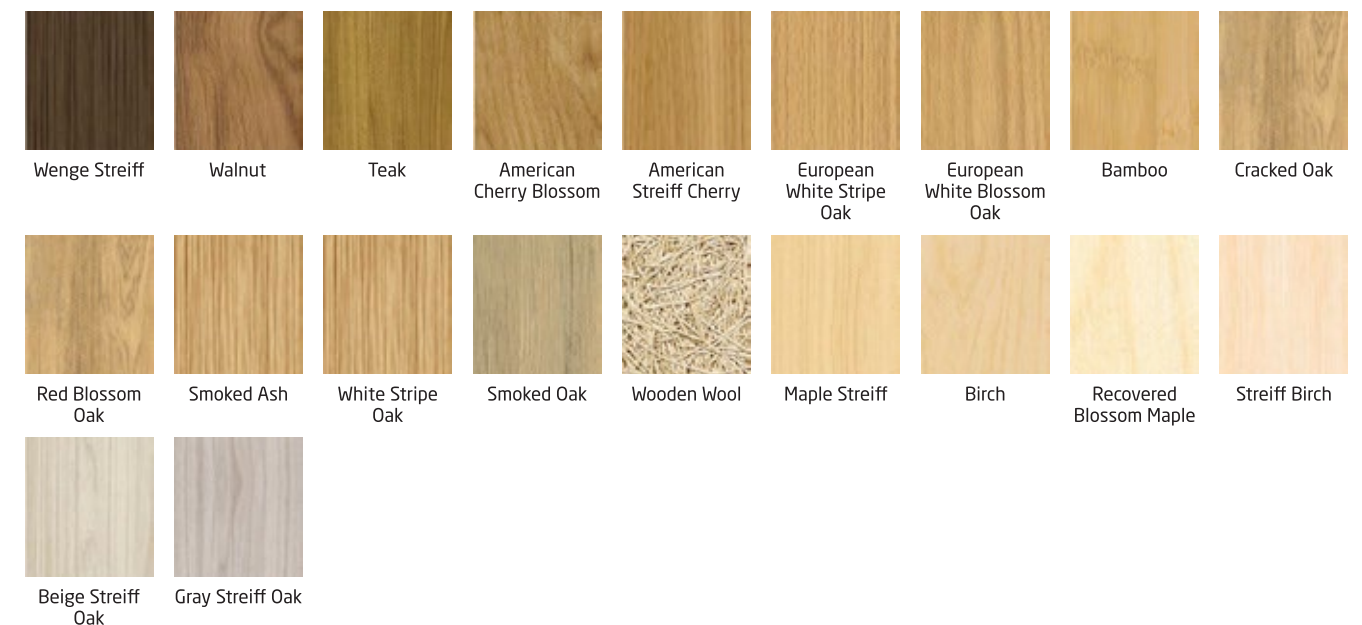

INFORMATION

A floating framed island - in the design of cells is a unique ceiling element in the space, Combining design and acoustics for perfect visibility. Aselection of shades from an existing fan of colors. Can be painted in any desired shade.

PROPERTIES



Acoustic Absorption

Our products poses a superb acoustic quality: NRC=0.4-0.95 in a variety of implementation applications that enable the creation of an ideal living environment, pleasant and of high quality, well suited for office spaces, halls, education structures and entertainment places.

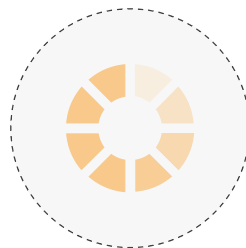

Color Fading

Assessment of colour fastness according to EN 1587 Assessed against the grey scale ISO 105-A02.

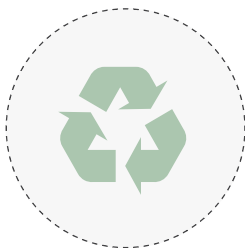

Recycled

The boards are made of 100% polyester PET, of which about 70% is recycled from drinking bottles.



Sustainability

Our PET Felt products contains post-consumer PET, does not contain any lead or tin, nor does it emit any (VOC) off gasses. It is recyclable and durable material, suitable for every environment.



Fire Reaction

Our products are manufactured in Israel according to the European fireproofing standard EN13501-I and American ASTM84 Class A.



Cleaning

Can be simply done using a damp cloth and vacuum cleaner.



SPECIFICATION

PRODUCT	Cell Size (mm)	Height (mm)	Thickness (mm)
Kea Grid	200x200	100	12
	300x300	150	24
	400x400	200	
	600x600	300	

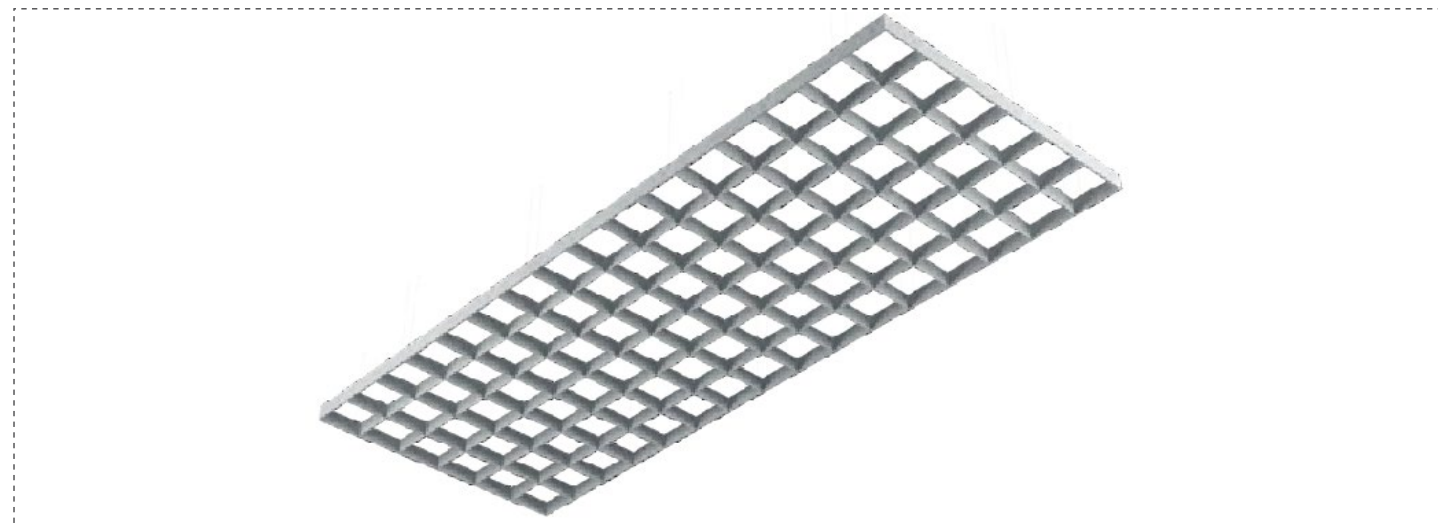

COLOR PALETTE

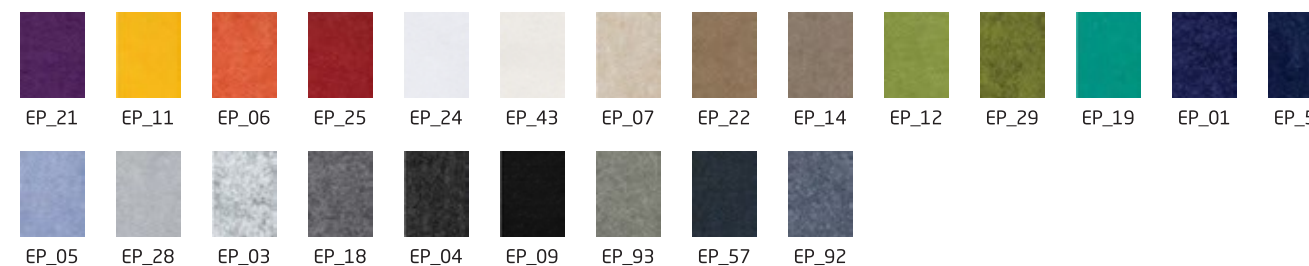

WOOD COLLECTION

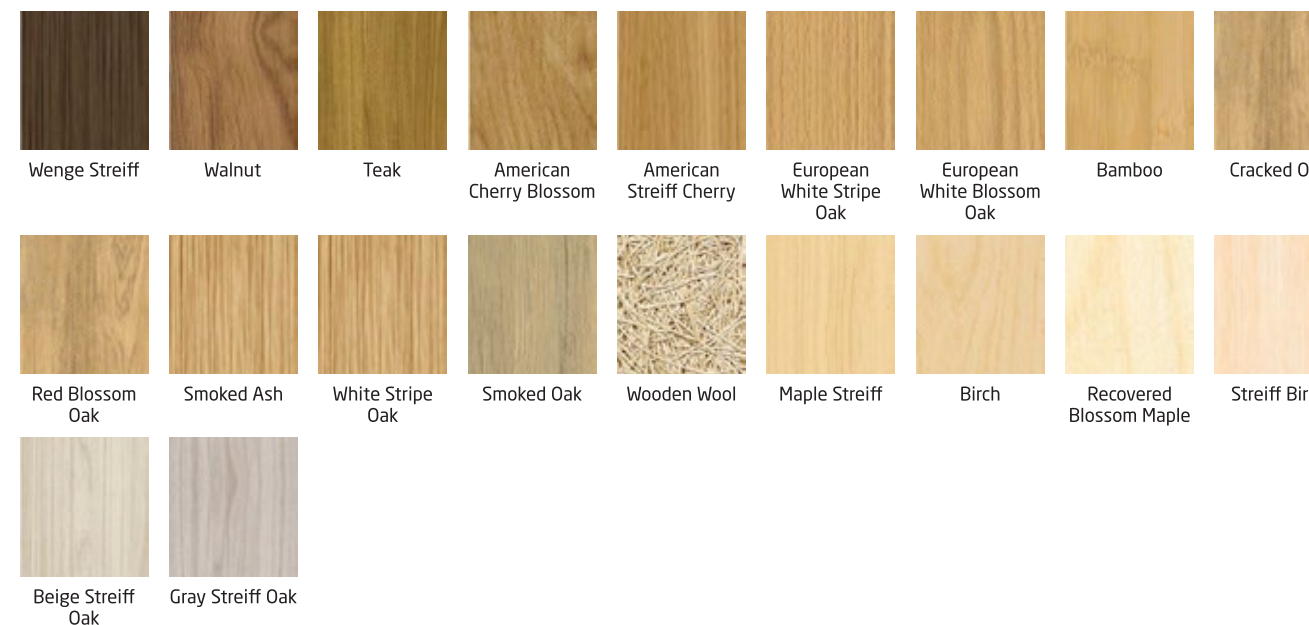

INFORMATION

Demountable grid ceiling comes in varying sizes and dimensions. Exists in two hanging methods - hanging as a free unit and hanging on a peripheral profile. Customized sizes are available.

PROPERTIES



Acoustic Absorption

Our products poses a superb acoustic quality: NRC=0.4-0.95 in a variety of implementation applications that enable the creation of an ideal living environment, pleasant and of high quality, well suited for office spaces, halls, education structures and entertainment places.

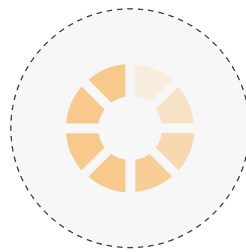

Color Fading

Assessment of colour fastness according to EN 1587 Assessed against the grey scale ISO 105-A02.

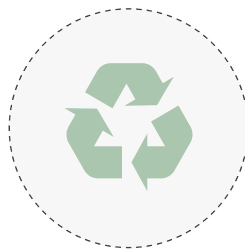

Recycled

The boards are made of 100% polyester PET, of which about 70% is recycled from drinking bottles.



Sustainability

Our PET Felt Products contains post-consumer PET, does not contain any lead or tin, nor does it emit any (VOC) off gasses. It is recyclable and durable material, suitable for every environment.



Fire Reaction

Our products are manufactured in Israel according to the European fireproofing standard EN13501-I and American ASTM84 Class A.



Cleaning

Can be simply done using a damp cloth and vacuum cleaner.



SPECIFICATION

PRODUCT	Main Cell Size (mm)	Tile Cell Size (mm)	Height (mm)	Thickness (mm)
Hydra Grid	600x600	150x150	100	12
		200x200	150	24
		300x300	200	
			300	

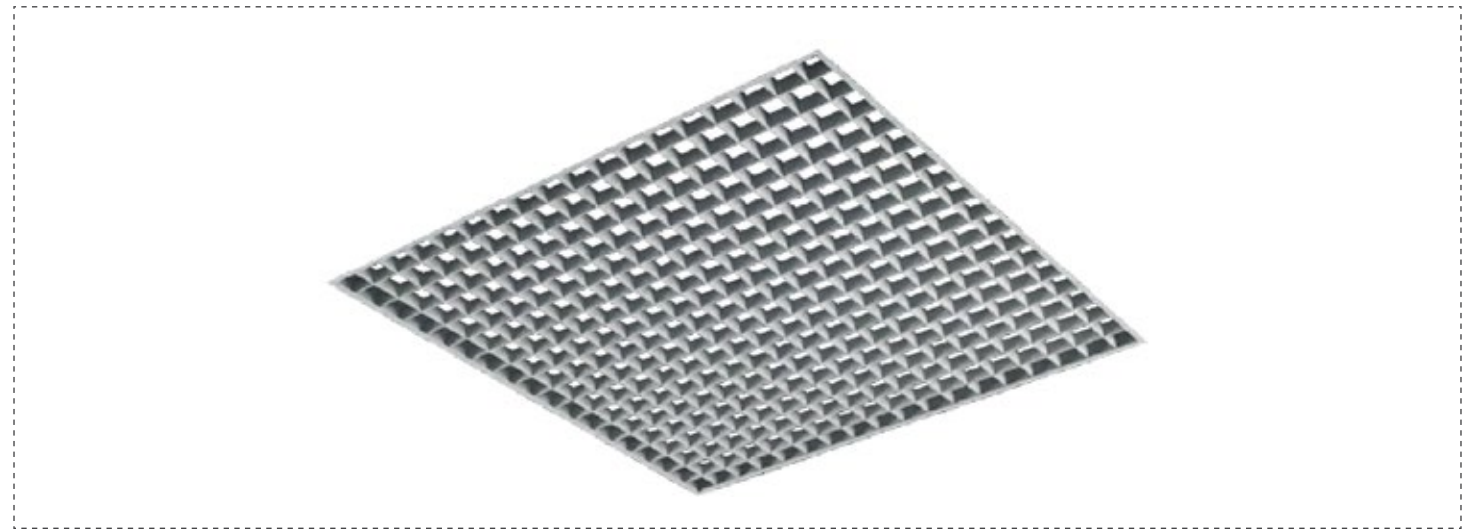

COLOR PALETTE

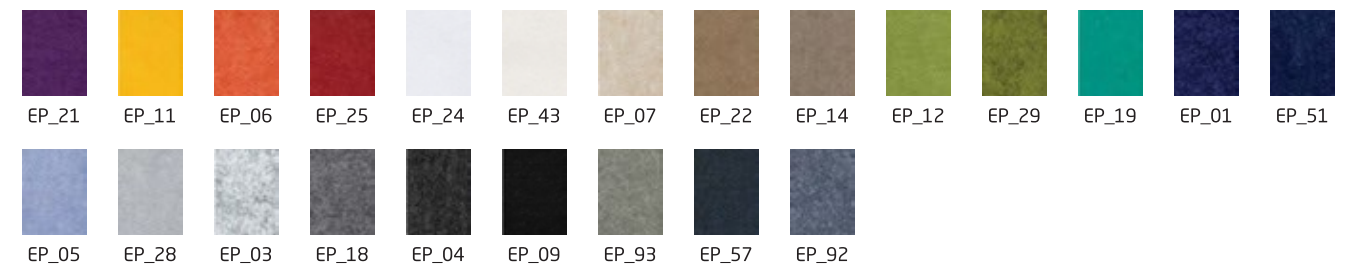

WOOD COLLECTION

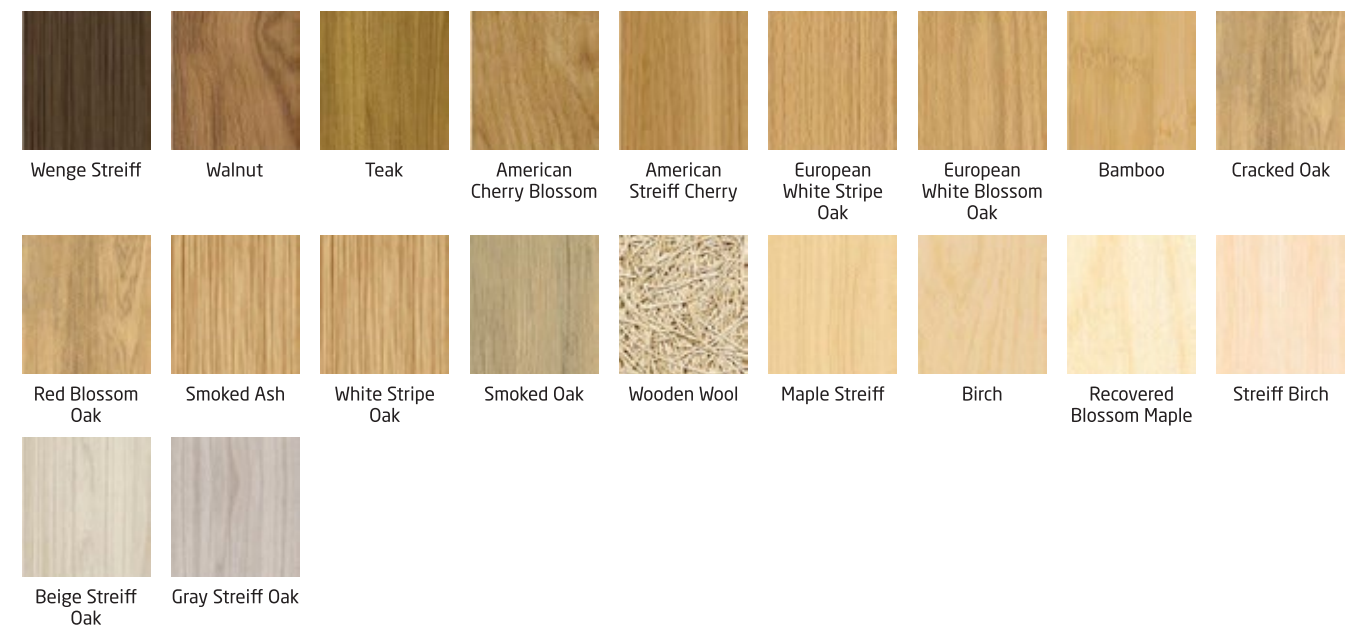

INFORMATION

Continuous elongated tiles that produce a continuous linear appearance to the space. Designed for narrow spaces such as corridors, can be unmounted very easily. The units connect to each other in a minimal disconnect slot.

PROPERTIES



Acoustic Absorption

Our products poses a superb acoustic quality: NRC=0.4-0.95 in a variety of implementation applications that enable the creation of an ideal living environment, pleasant and of high quality, well suited for office spaces, halls, education structures and entertainment places.

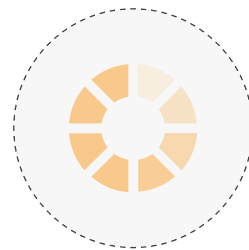

Color Fading

Assessment of colour fastness according to EN 1587 Assessed against the grey scale ISO 105-A02.

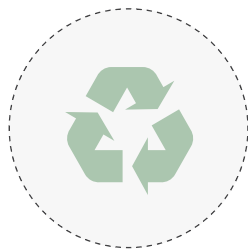

Recycled

The boards are made of 100% polyester PET, of which about 70% is recycled from drinking bottles.



Sustainability

Our PET Felt products contains post-consumer PET, does not contain any lead or tin, nor does it emit any (VOC) off gasses. It is recyclable and durable material, suitable for every environment.



Fire Reaction

Our products are manufactured in Israel according to the European fireproofing standard EN13501-I and American ASTM84 Class A.



Cleaning

Can be simply done using a damp cloth and vacuum cleaner.



SPECIFICATION

PRODUCT	Length (mm)	Thickness (mm)
Feltline Corridor	1200x600	6
	2400x600	9
		24

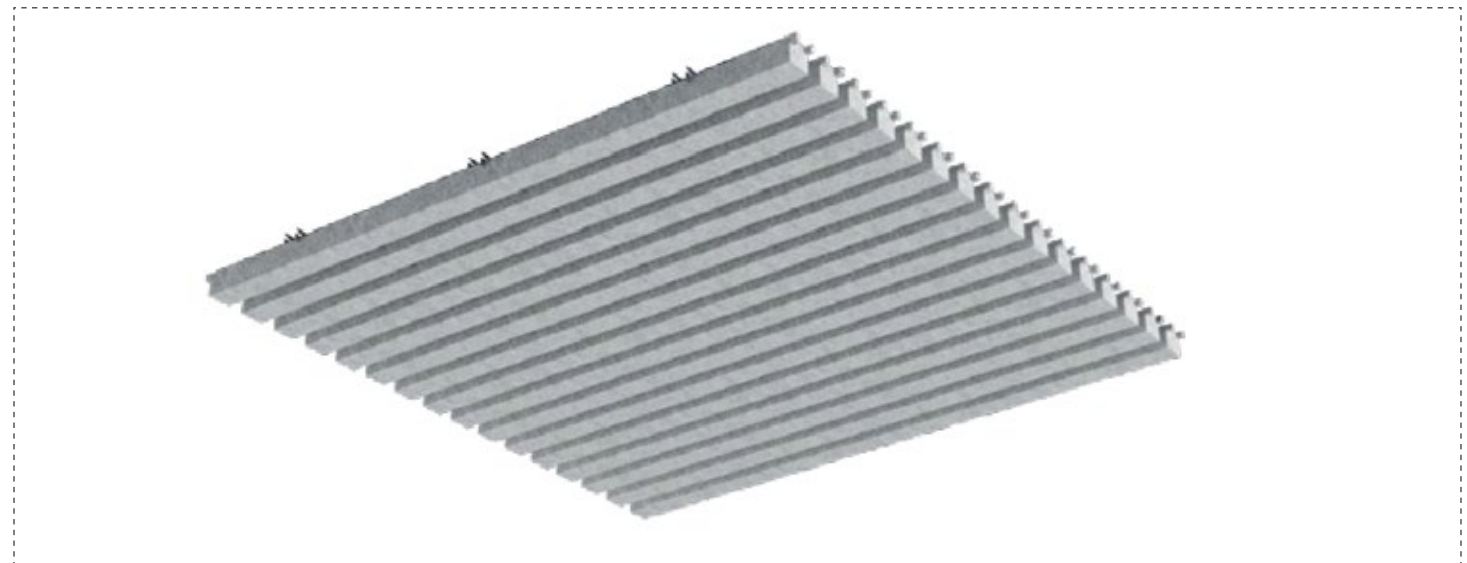

COLOR PALETTE

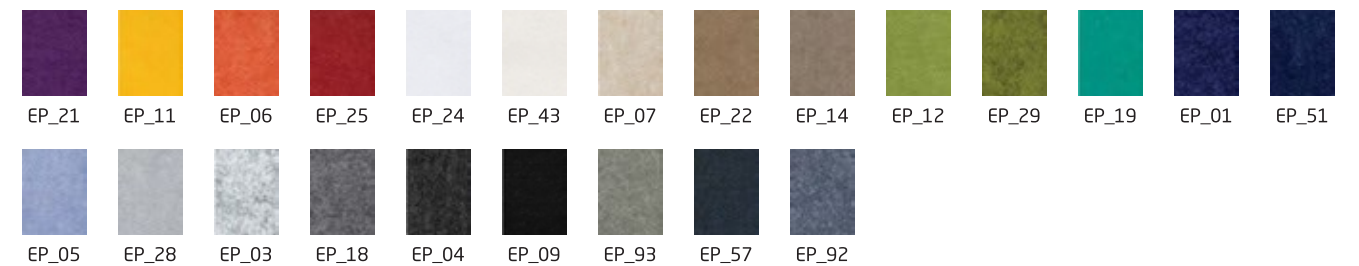

WOOD COLLECTION

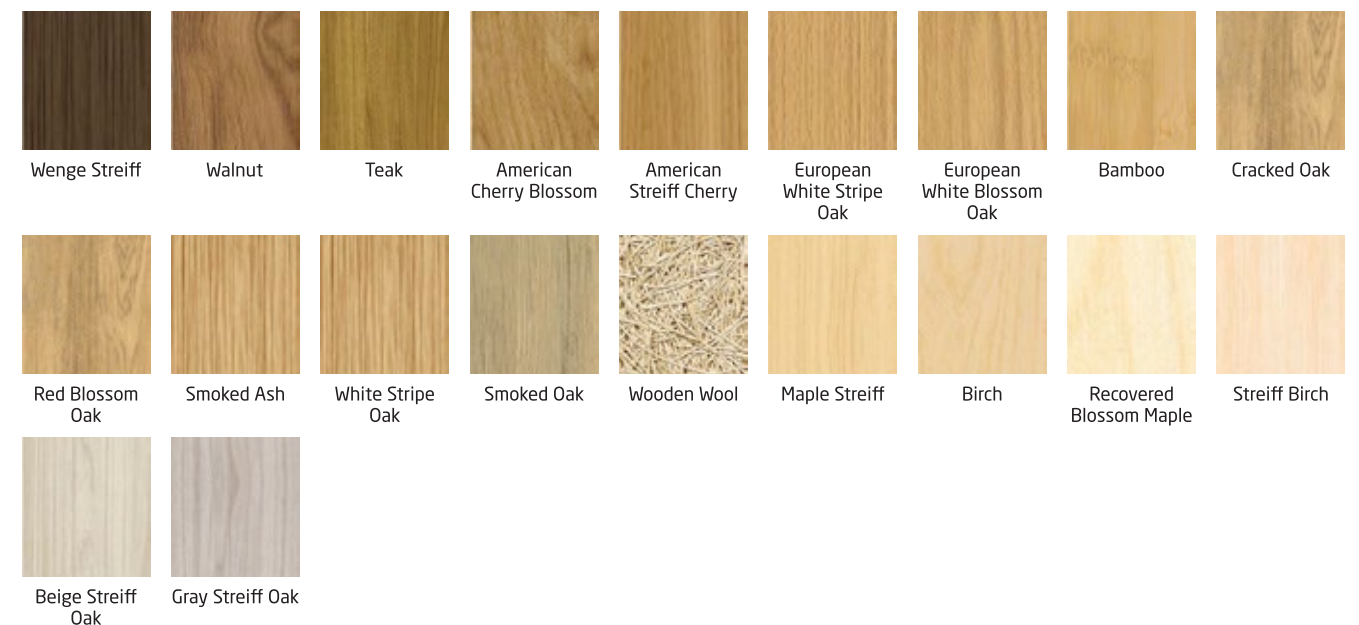

INFORMATION

A combination of frames and tiles that create a three-dimensional ceiling surface and excellent acoustics.

PROPERTIES



Acoustic Absorption

Our products poses a superb acoustic quality: NRC=0.4-0.95 in a variety of implementation applications that enable the creation of an ideal living environment, pleasant and of high quality, well suited for office spaces, halls, education structures and entertainment places.

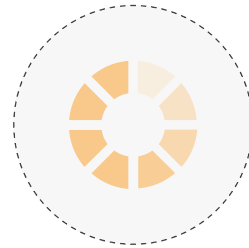

Color Fading

Assessment of colour fastness according to EN 1587 Assessed against the grey scale ISO 105-A02.

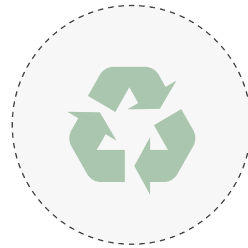

Recycled

The boards are made of 100% polyester PET, of which about 70% is recycled from drinking bottles.



Sustainability

Our PET Felt products contains post-consumer PET, does not contain any lead or tin, nor does it emit any (VOC) off gasses. It is recyclable and durable material, suitable for every environment.



Fire Reaction

Our products are manufactured in Israel according to the European fireproofing standard EN13501-I and American ASTM84 Class A.



Cleaning

Can be simply done using a damp cloth and vacuum cleaner.



SPECIFICATION

PRODUCT	Length (mm)	Height (mm)	Thickness (mm)
Diagonal	600x600	50-100	12



COLOR PALETTE

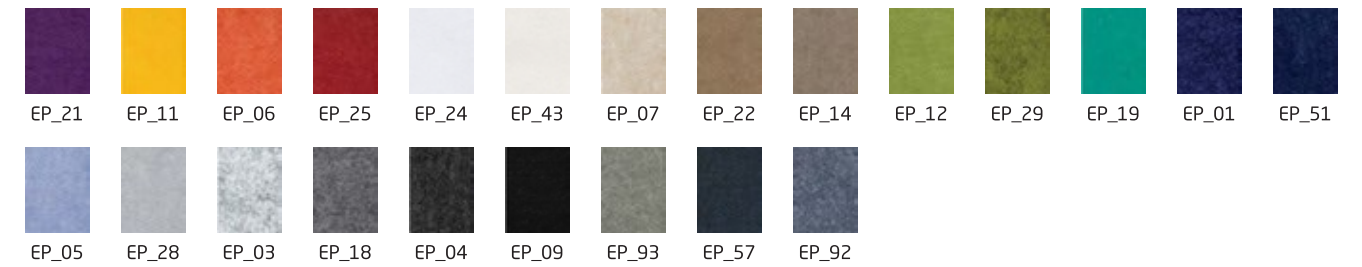

WOOD COLLECTION



INFORMATION

Continuous elongated tiles that produce a continuous linear appearance to the space. The units connect to each other in a minimal disconnect slot.

PROPERTIES



Acoustic Absorption

Our products poses a superb acoustic quality: NRC=0.4-0.95 in a variety of implementation applications that enable the creation of an ideal living environment, pleasant and of high quality, well suited for office spaces, halls, education structures and entertainment places.

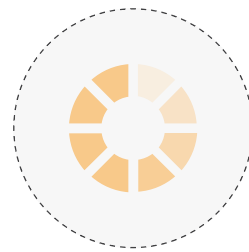

Color Fading

Assessment of colour fastness according to EN 1587 Assessed against the grey scale ISO 105-A02.

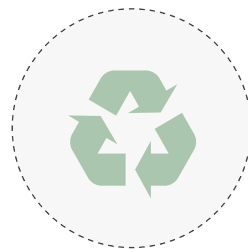

Recycled

The boards are made of 100% polyester PET, of which about 70% is recycled from drinking bottles.



Sustainability

Our PET Felt products contains post-consumer PET, does not contain any lead or tin, nor does it emit any (VOC) off gasses. It is recyclable and durable material, suitable for every environment.



Fire Reaction

Our products are manufactured in Israel according to the European fireproofing standard EN13501-I and American ASTM84 Class A.



Cleaning

Can be simply done using a damp cloth and vacuum cleaner.

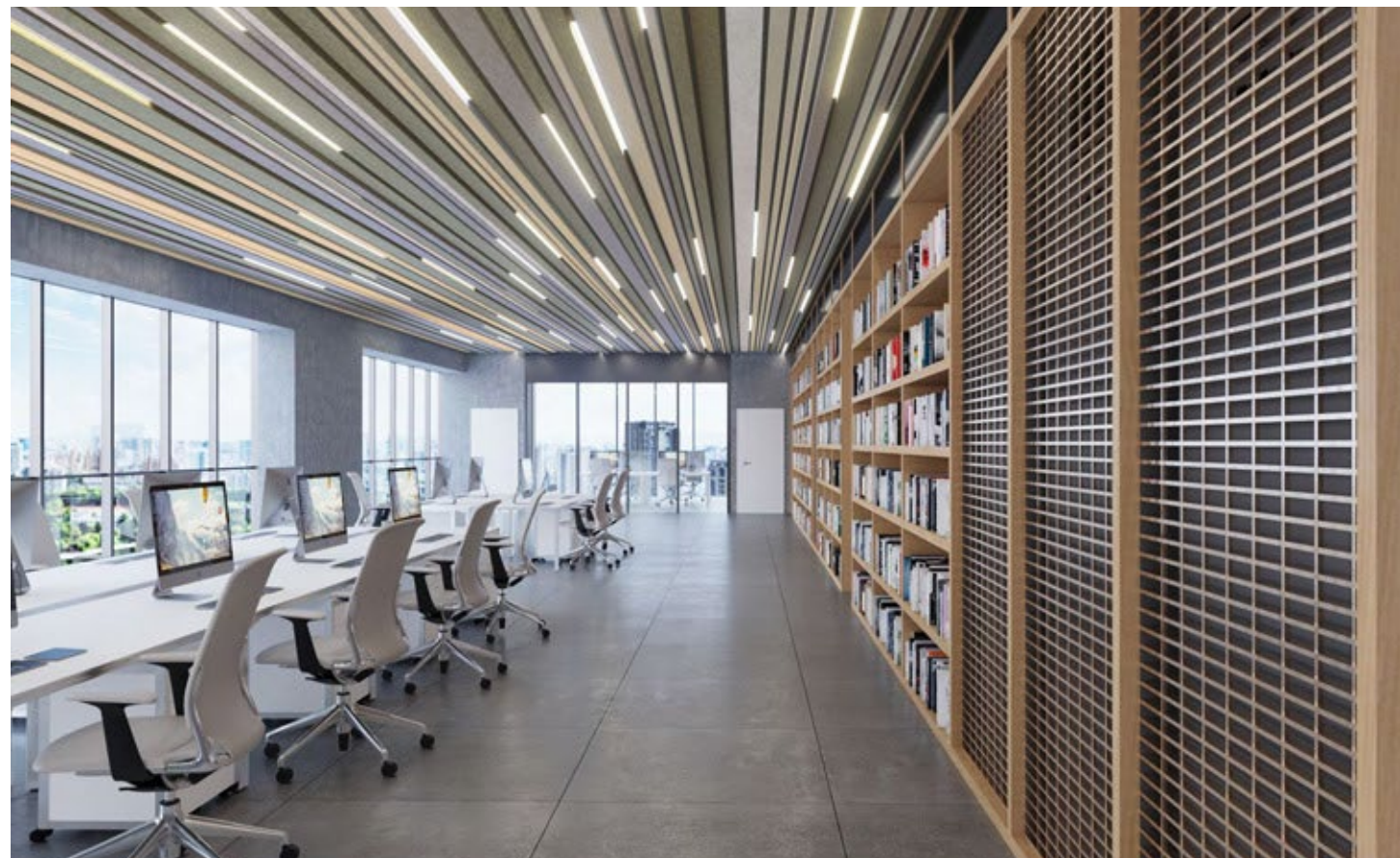

SPECIFICATION

PRODUCT	Length (mm)	Thickness (mm)
Barcode	1200x600	6
	2400x600	9

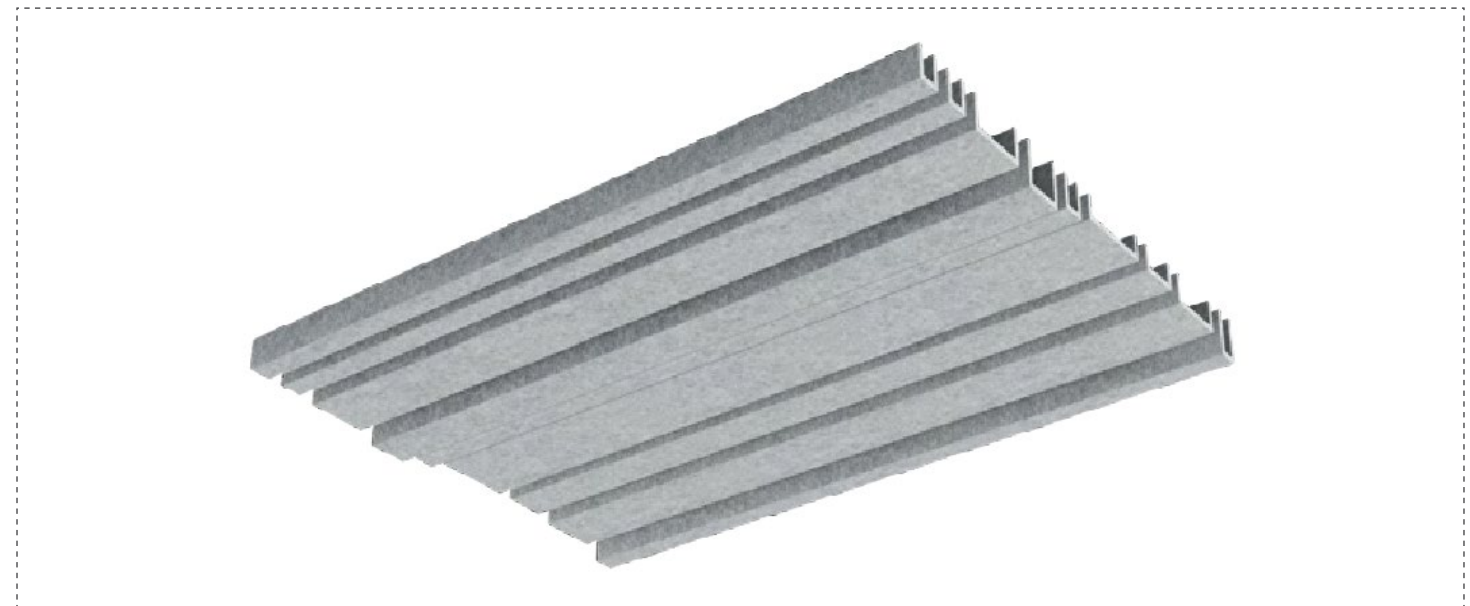

COLOR PALETTE

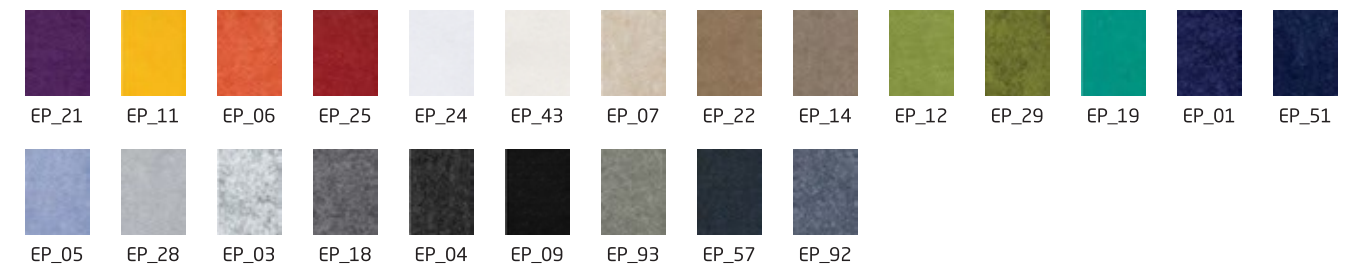

WOOD COLLECTION

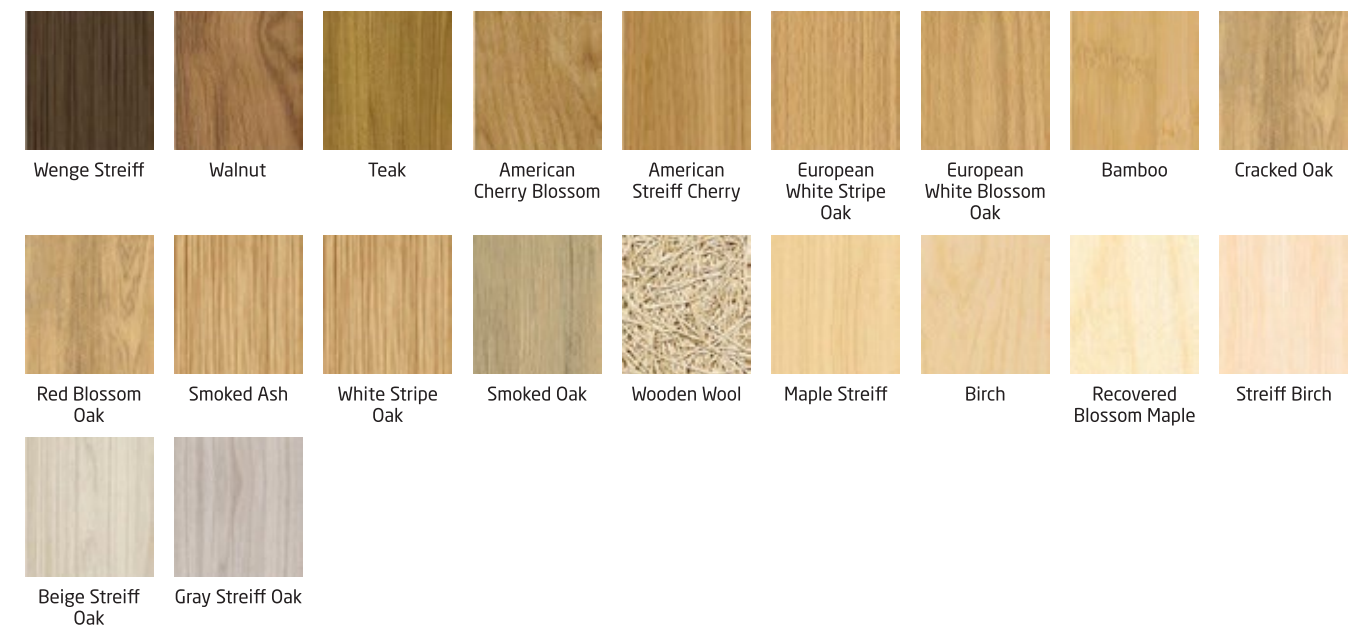

INFORMATION

A cluster of varying sizes and heights of cube tiles produces an impressive three-dimensional ceiling with high-quality acoustic values.

PROPERTIES



Acoustic Absorption

Our products poses a superb acoustic quality: NRC=0.4-0.95 in a variety of implementation applications that enable the creation of an ideal living environment, pleasant and of high quality, well suited for office spaces, halls, education structures and entertainment places.

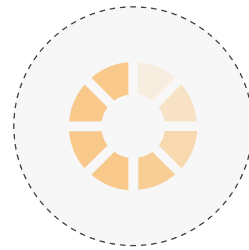

Color Fading

Assessment of colour fastness according to EN 1587 Assessed against the grey scale ISO 105-A02.

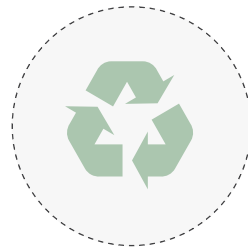

Recycled

The boards are made of 100% polyester PET, of which about 70% is recycled from drinking bottles.



Sustainability

Our PET Felt Products contains post-consumer PET, does not contain any lead or tin, nor does it emit any (VOC) off gasses. It is recyclable and durable material, suitable for every environment.



Fire Reaction

Our products are manufactured in Israel according to the European fireproofing standard EN13501-I and American ASTM84 Class A.



Cleaning

Can be simply done using a damp cloth and vacuum cleaner.

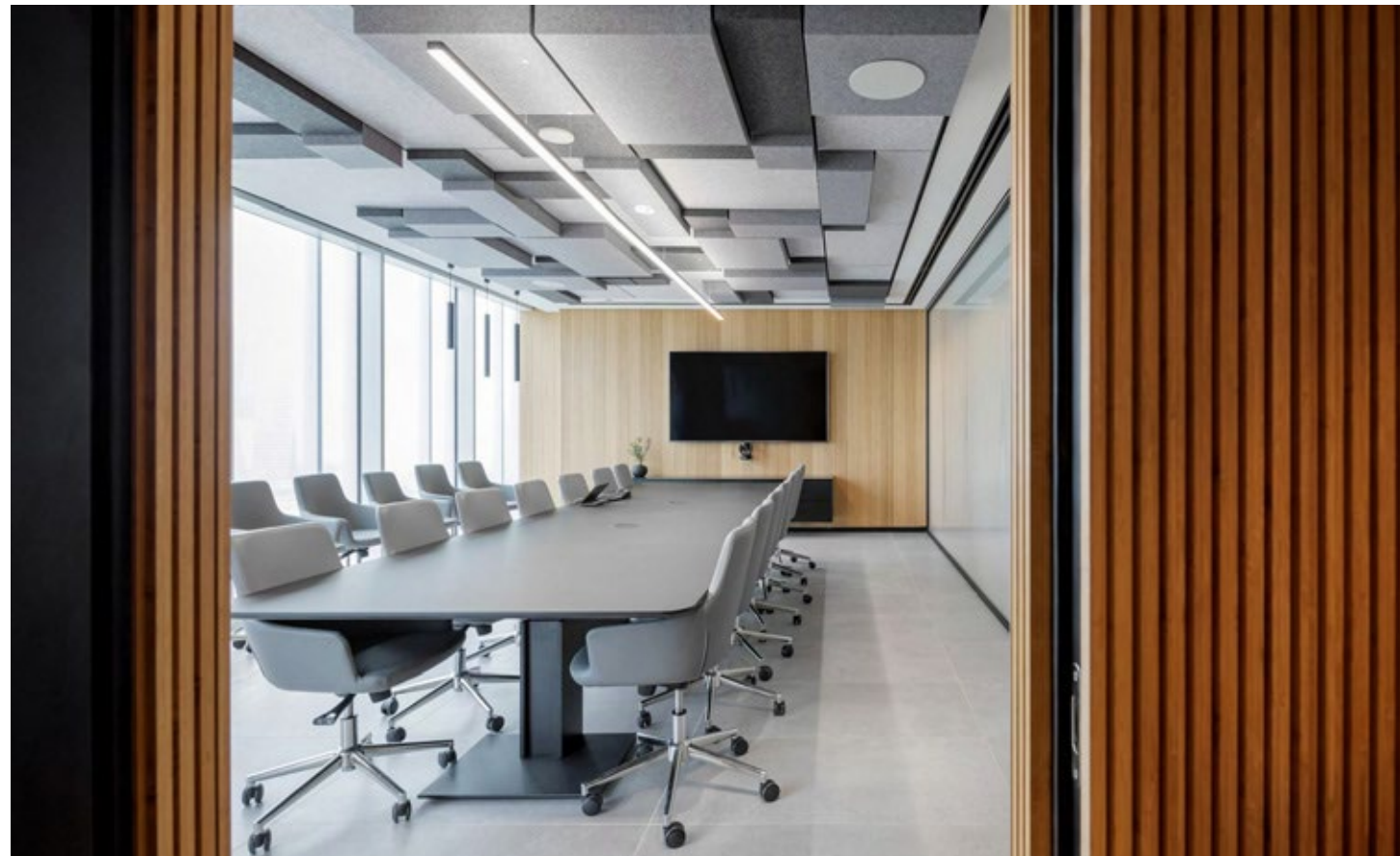

SPECIFICATION

PRODUCT	Module Size (mm)	Height (mm)	Thickness (mm)
Modular Cubes	2400x2400	50-200	9

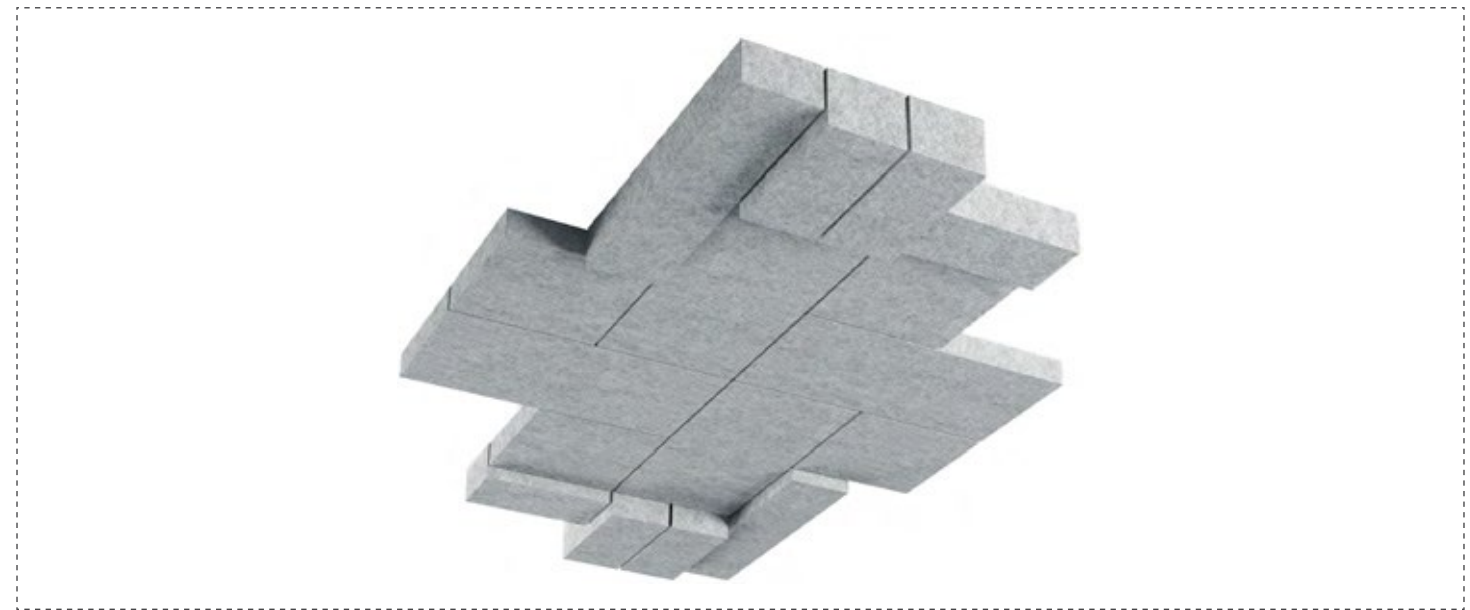

COLOR PALETTE

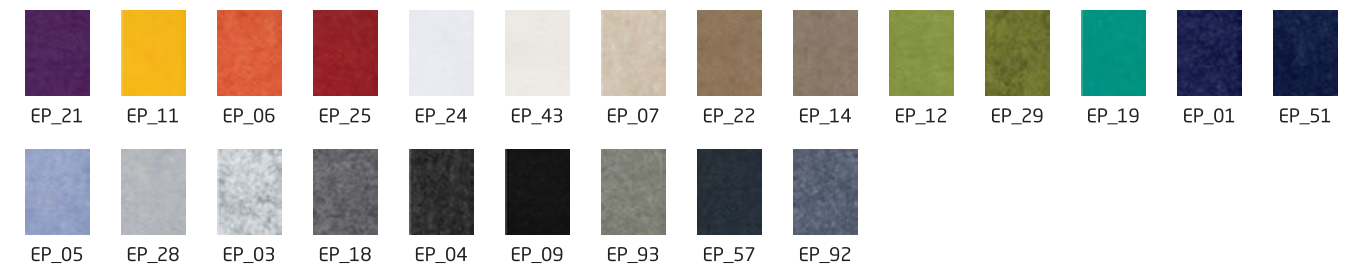

WOOD COLLECTION

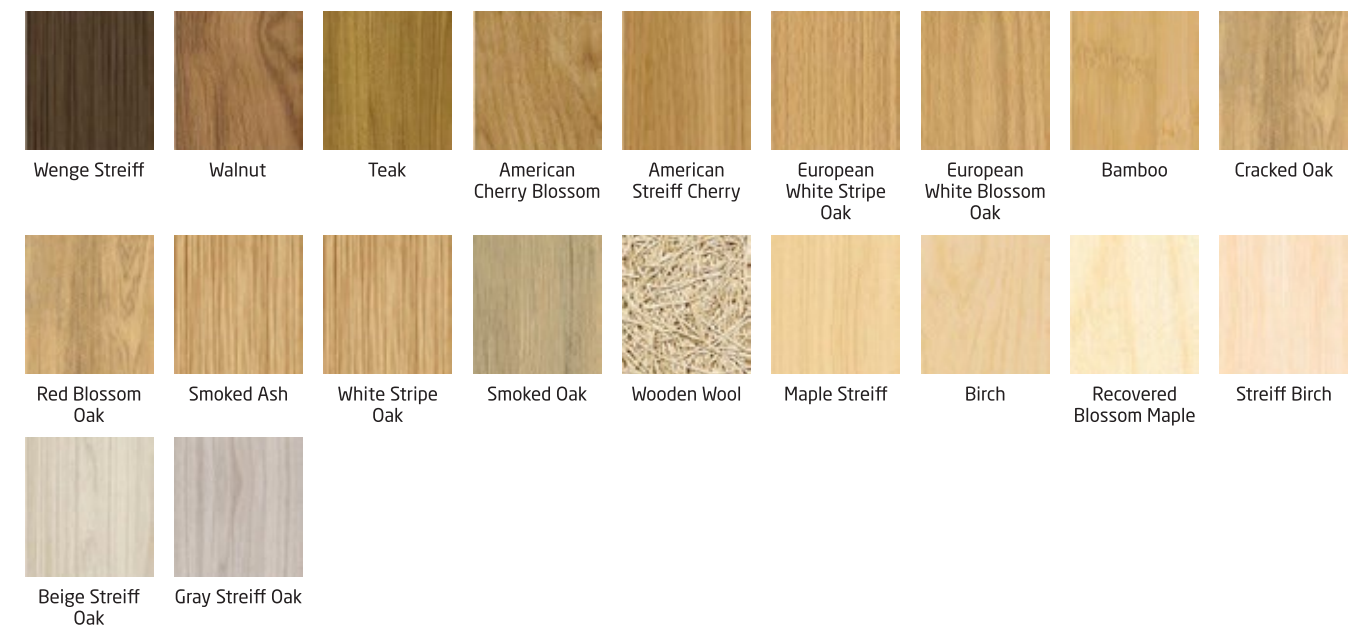

INFORMATION

The grooved tiles are series in a geometrical shape, forming a unit in a continuance pattern. The pattern is repetitive - the tiles connect on all edges.

PROPERTIES



Acoustic Absorption

Our products poses a superb acoustic quality: NRC=0.4-0.95 in a variety of implementation applications that enable the creation of an ideal living environment, pleasant and of high quality, well suited for office spaces, halls, education structures and entertainment places.

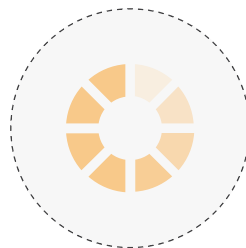

Color Fading

Assessment of colour fastness according to EN 1587 Assessed against the grey scale ISO 105-A02.

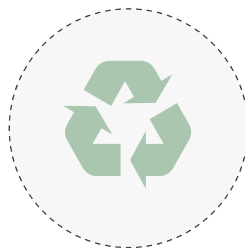

Recycled

The boards are made of 100% polyester PET, of which about 70% is recycled from drinking bottles.



Sustainability

Our PET Felt products contains post-consumer PET, does not contain any lead or tin, nor does it emit any (VOC) off gasses. It is recyclable and durable material, suitable for every environment.



Fire Reaction

Our products are manufactured in Israel according to the European fireproofing standard EN13501-I and American ASTM84 Class A.



Cleaning

Can be simply done using a damp cloth and vacuum cleaner.



SPECIFICATION

PRODUCT	Size (mm)	Thickness (mm)
Grooved	600x600	9
		12



Glued

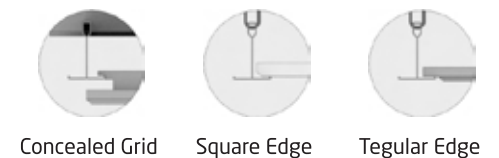

Concealed Grid Square Edge Tegular Edge

MODELS

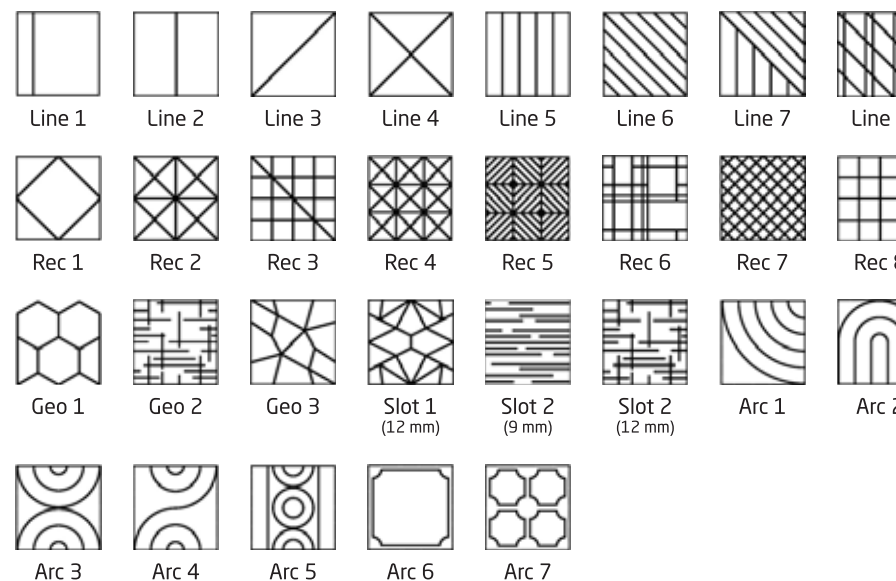

COLOR PALETTE

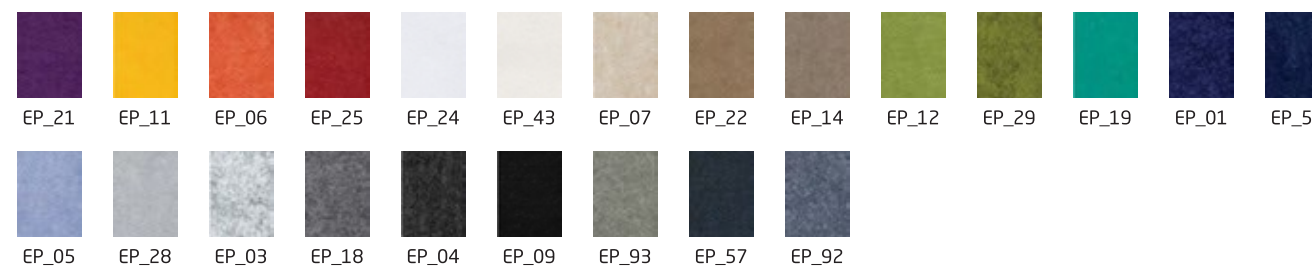

WOOD COLLECTION

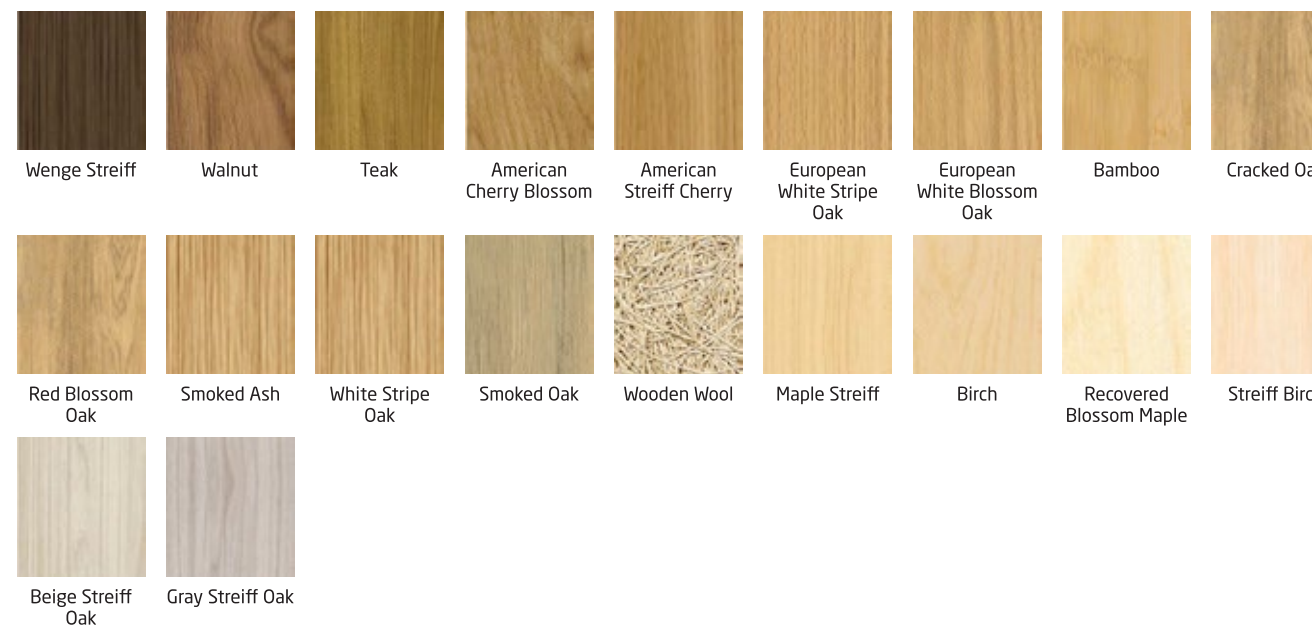

INFORMATION

Baffle is vertically installed unframed units. It is available in different sizes and a wide range of colors. Two hanging methods: free hanging of each of the baffles or using a connector profile that maintains a uniform hanging. Customized sizes are available.

PROPERTIES



Acoustic Absorption

Our products poses a superb acoustic quality: NRC=0.4-0.95 in a variety of implementation applications that enable the creation of an ideal living environment, pleasant and of high quality, well suited for office spaces, halls, education structures and entertainment places.

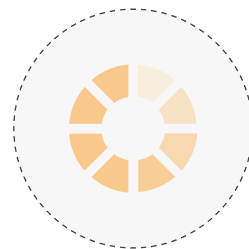

Color Fading

Assessment of colour fastness according to EN 1587 Assessed against the grey scale ISO 105-A02.

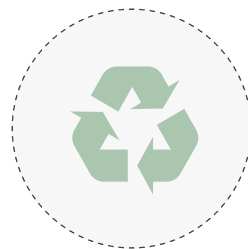

Recycled

The boards are made of 100% polyester PET, of which about 70% is recycled from drinking bottles.



Sustainability

Our PET Felt products contains post-consumer PET, does not contain any lead or tin, nor does it emit any (VOC) off gasses. It is recyclable and durable material, suitable for every environment.



Fire Reaction

Our products are manufactured in Israel according to the European fireproofing standard EN13501-I and American ASTM84 Class A.



Cleaning

Can be simply done using a damp cloth and vacuum cleaner.



SPECIFICATION

PRODUCT	Max Length (mm)	Height (mm)	Thickness (mm)
Baffle Wave		200	12
		300	24
		400	

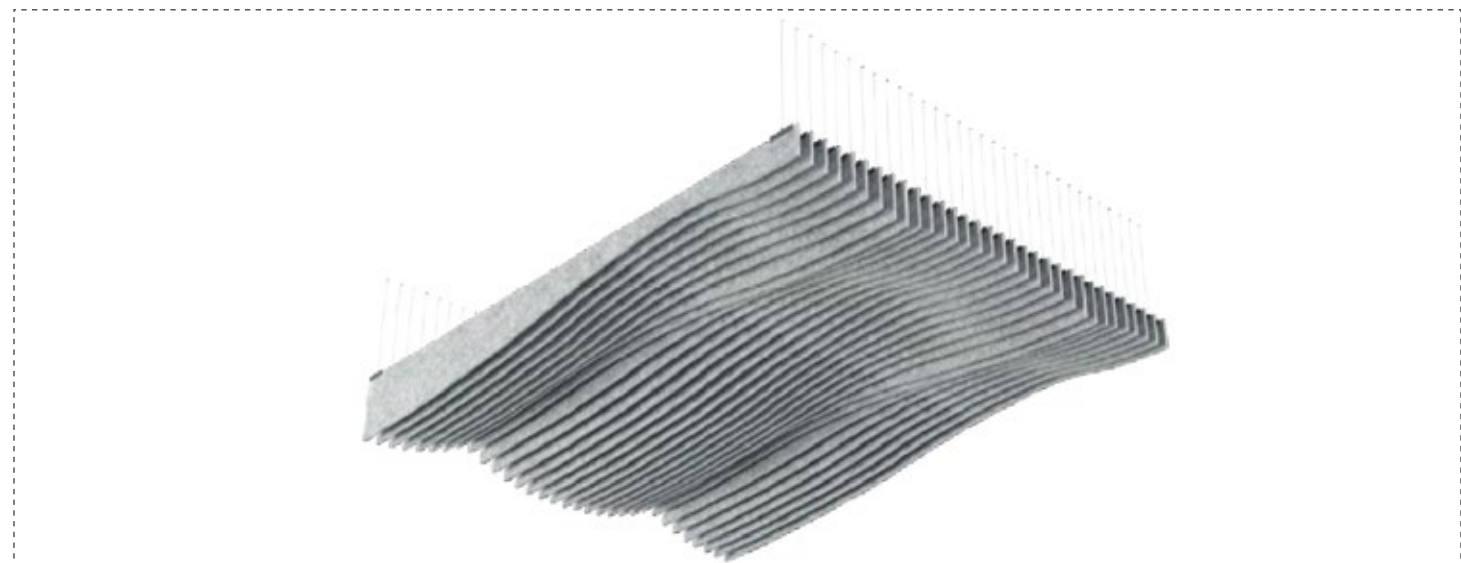

COLOR PALETTE

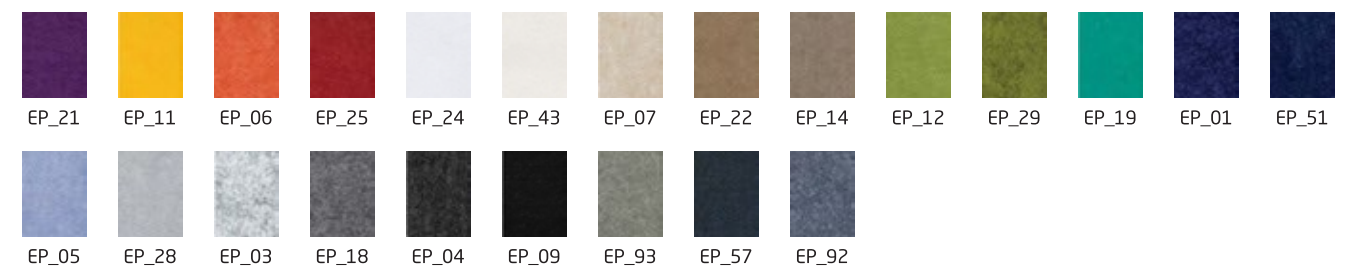

WOOD COLLECTION

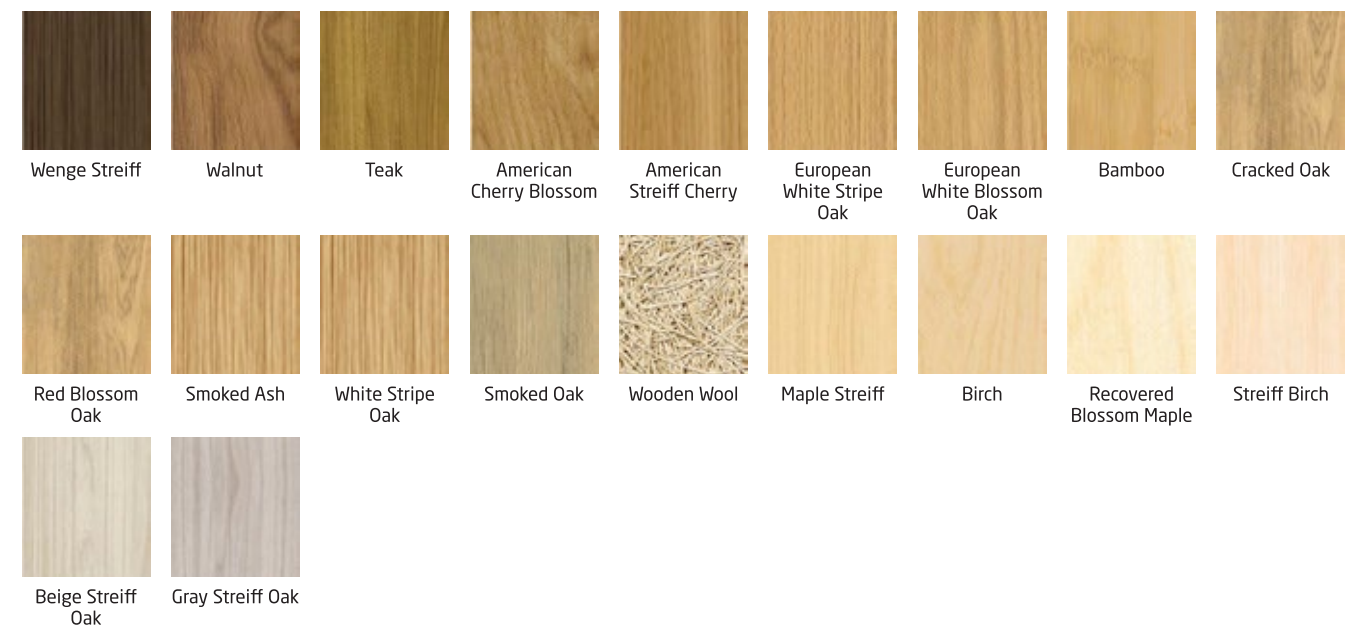

INFORMATION

The Galaxy is a striking round element composed of vertical tiles, featuring a unique striped look, and offering different heights or thicknesses for the baffles. It can be installed as a floating element or securely screwed close to an existing ceiling, providing versatile design possibilities.

PROPERTIES



Acoustic Absorption

Our products poses a superb acoustic quality: NRC=0.4-0.95 in a variety of implementation applications that enable the creation of an ideal living environment, pleasant and of high quality, well suited for office spaces, halls, education structures and entertainment places.

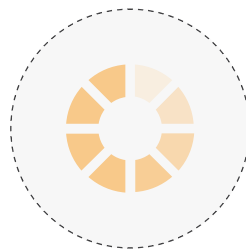

Color Fading

Assessment of colour fastness according to EN 1587 Assessed against the grey scale ISO 105-A02.

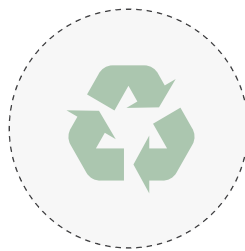

Recycled

The boards are made of 100% polyester PET, of which about 70% is recycled from drinking bottles.



Sustainability

Our PET Felt products contains post-consumer PET, does not contain any lead or tin, nor does it emit any (VOC) off gasses. It is recyclable and durable material, suitable for every environment.



Fire Reaction

Our products are manufactured in Israel according to the European fireproofing standard EN13501-1 and American ASTM84 Class A.



Cleaning

Can be simply done using a damp cloth and vacuum cleaner.



SPECIFICATION

PRODUCT	Max Length (mm)	Height (mm)	Thickness (mm)
Galaxy		200	12
		300	24
		400	

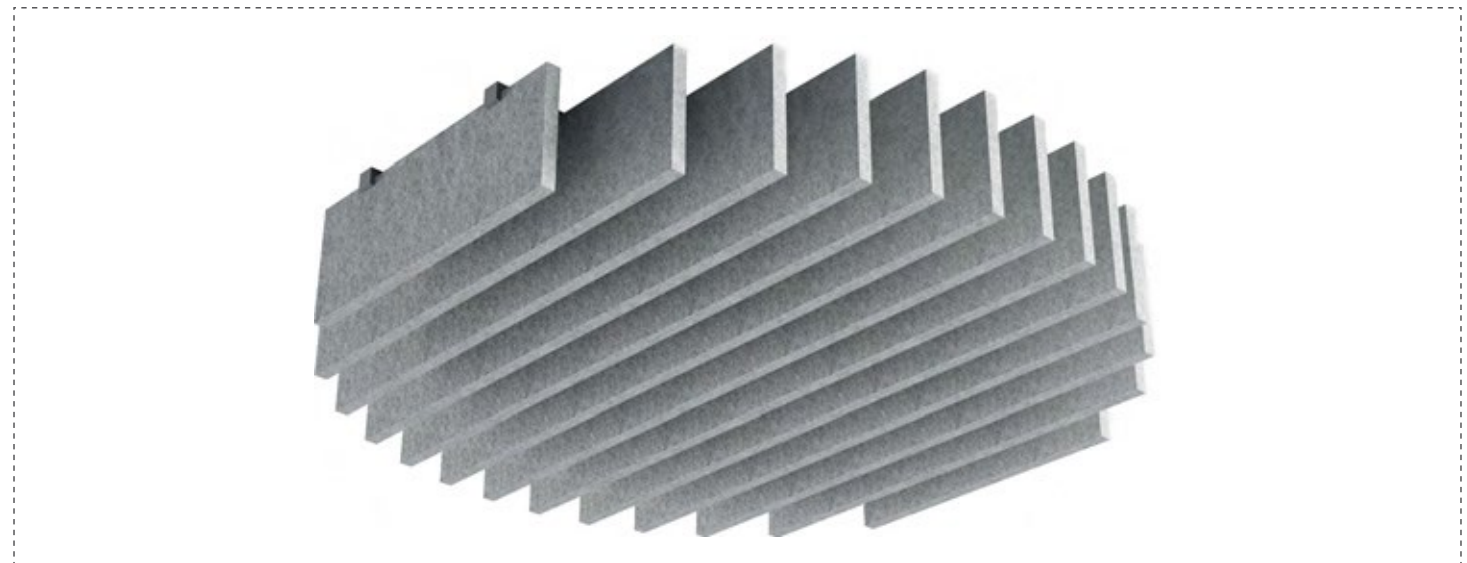

COLOR PALETTE

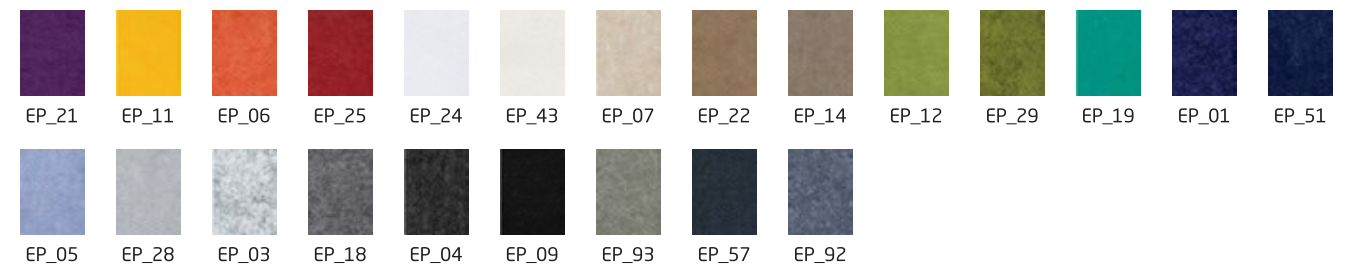

WOOD COLLECTION

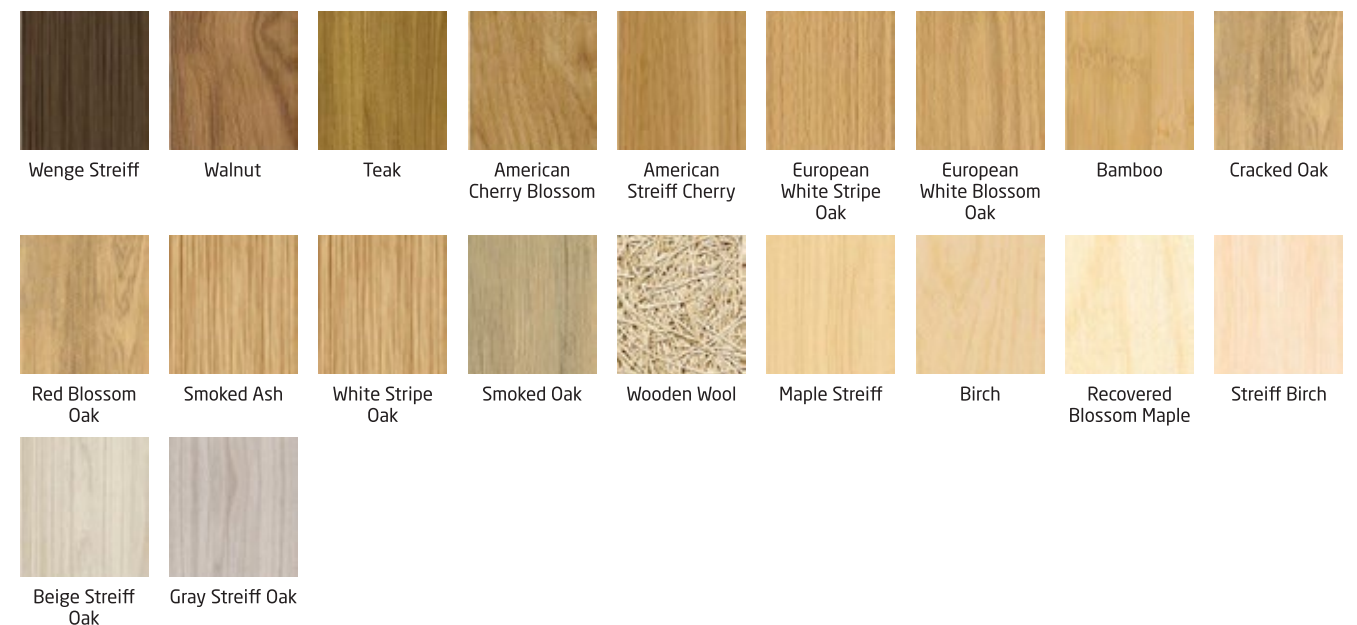

INFORMATION

Baffle is vertically installed unframed units. It is available in different sizes and a wide range of colors. Two hanging methods: free hanging of each of the baffles or using a connector profile that maintains a uniform hanging. Customized sizes are available.

PROPERTIES



Acoustic Absorption

Our products poses a superb acoustic quality: NRC=0.4-0.95 in a variety of implementation applications that enable the creation of an ideal living environment, pleasant and of high quality, well suited for office spaces, halls, education structures and entertainment places.

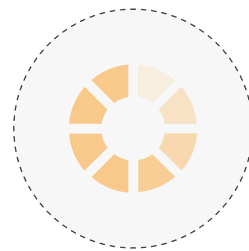

Color Fading

Assessment of colour fastness according to EN 1587 Assessed against the grey scale ISO 105-A02.

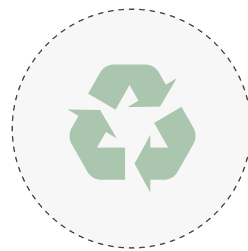

Recycled

The boards are made of 100% polyester PET, of which about 70% is recycled from drinking bottles.



Sustainability

Our PET Felt products contains post-consumer PET, does not contain any lead or tin, nor does it emit any (VOC) off gasses. It is recyclable and durable material, suitable for every environment.



Fire Reaction

Our products are manufactured in Israel according to the European fireproofing standard EN13501-I and American ASTM84 Class A.



Cleaning

Can be simply done using a damp cloth and vacuum cleaner.



SPECIFICATION

PRODUCT	Max Length (mm)	Height (mm)	Thickness (mm)
Baffle		200	12
		300	24
		400	

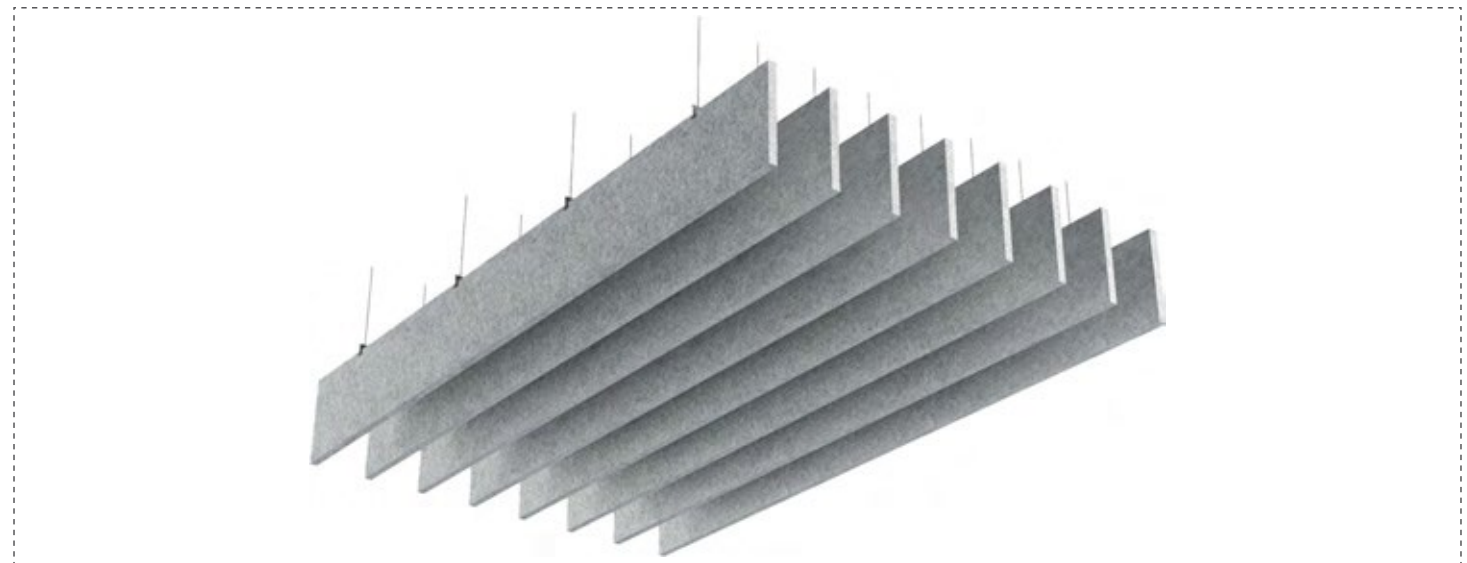

COLOR PALETTE

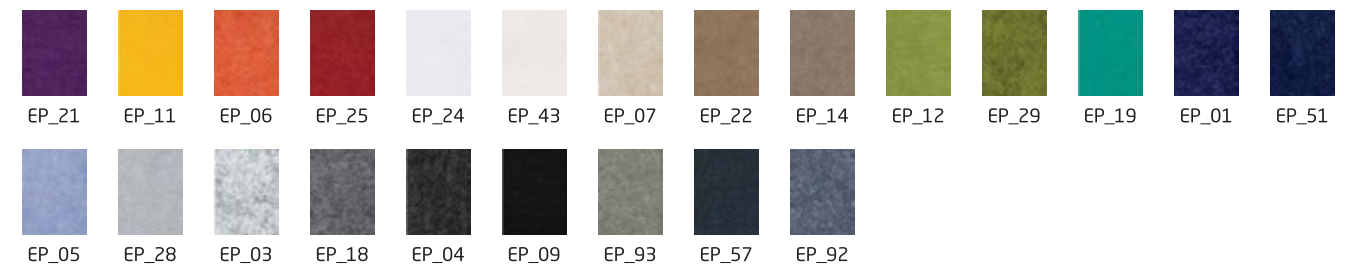

WOOD COLLECTION

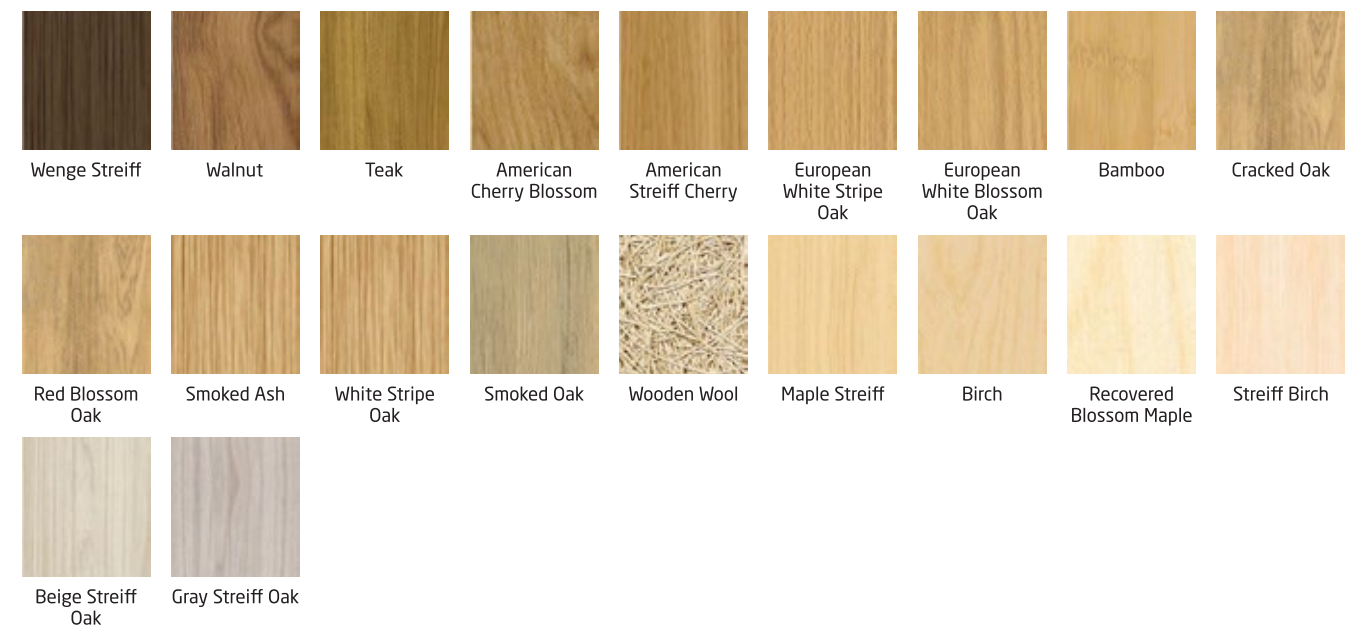

INFORMATION

Continuous elongated tiles that produce a continuous linear appearance to the space. The units connect to each other in a minimal disconnect slot.

PROPERTIES



Acoustic Absorption

Our products poses a superb acoustic quality: NRC=0.4-0.95 in a variety of implementation applications that enable the creation of an ideal living environment, pleasant and of high quality, well suited for office spaces, halls, education structures and entertainment places.

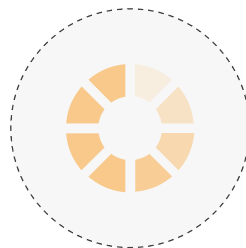

Color Fading

Assessment of colour fastness according to EN 1587 Assessed against the grey scale ISO 105-A02.

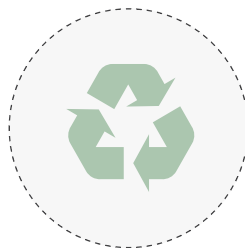

Recycled

The boards are made of 100% polyester PET, of which about 70% is recycled from drinking bottles.



Sustainability

Our PET Felt products contains post-consumer PET, does not contain any lead or tin, nor does it emit any (VOC) off gasses. It is recyclable and durable material, suitable for every environment.



Fire Reaction

Our products are manufactured in Israel according to the European fireproofing standard EN13501-I and American ASTM84 Class A.



Cleaning

Can be simply done using a damp cloth and vacuum cleaner.



SPECIFICATION

PRODUCT	Length (mm)	Thickness (mm)
Feltline	1200x600	6
	2400x600	9

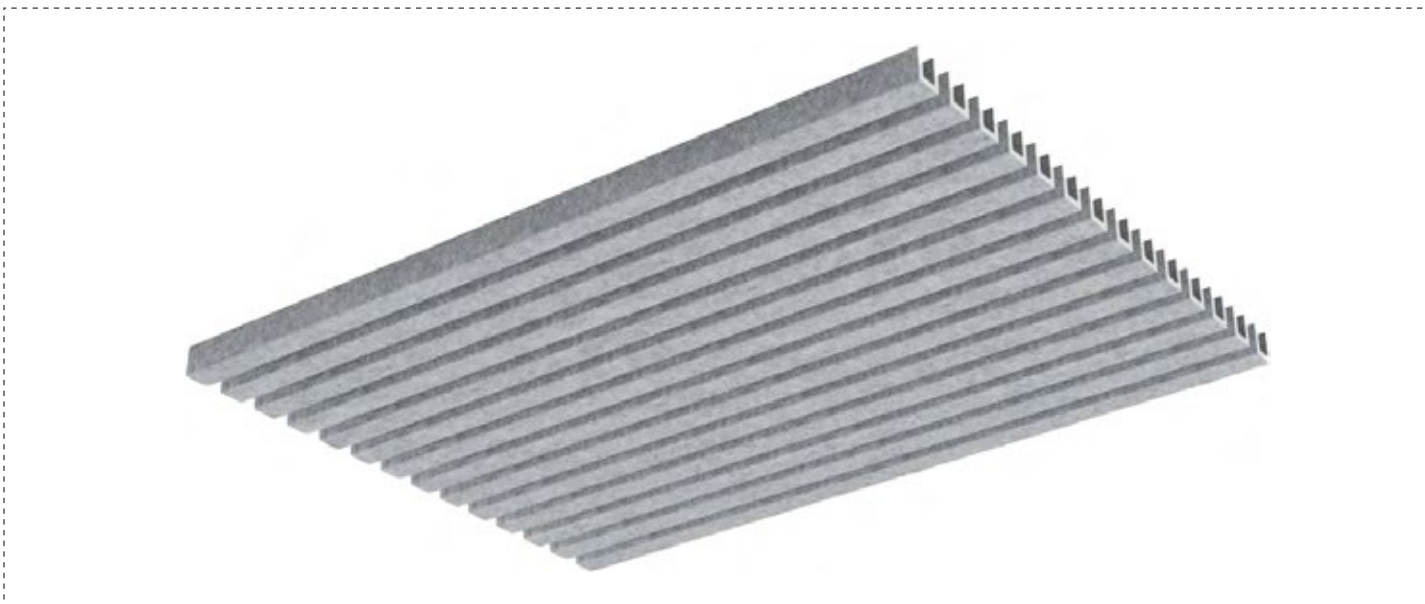

COLOR PALETTE

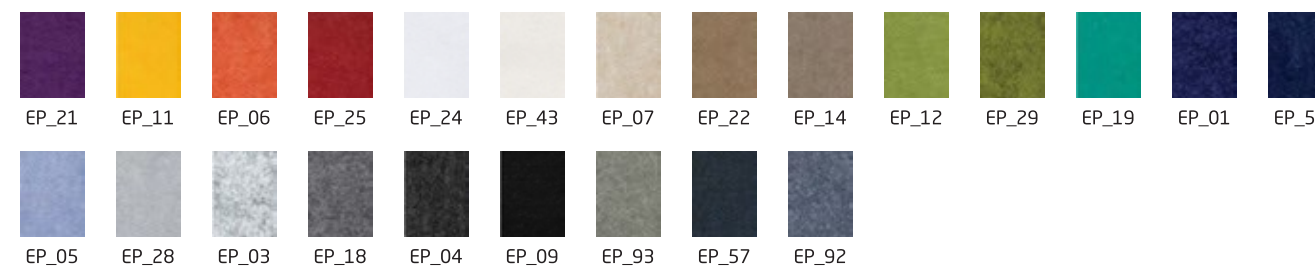

WOOD COLLECTION

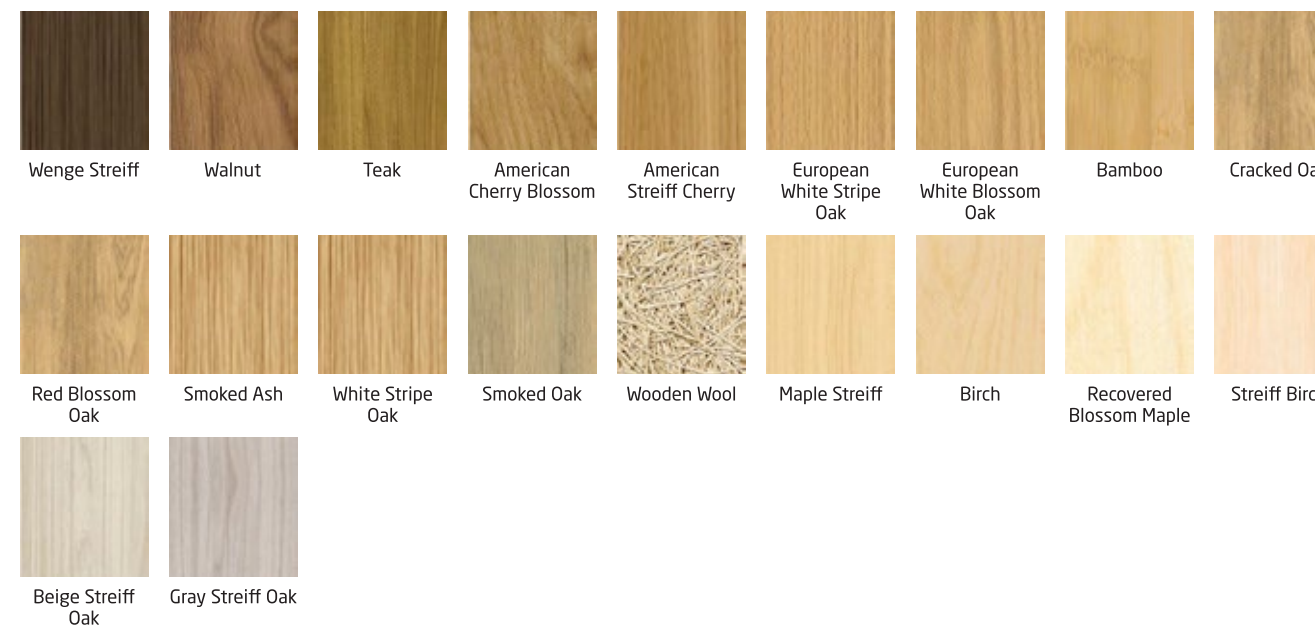



Chapter

02

 **integra**[®]
FELTLINE CEILING SYSTEMS

Grooved

- Slot
- Rec
- Geo
- Line

INFORMATION

A selection of shades from an existing color palette. Can be painted in any desirable shade.

PROPERTIES



Acoustic Absorption

Our products poses a superb acoustic quality: NRC=0.4-0.95 in a variety of implementation applications that enable the creation of an ideal living environment, pleasant and of high quality, well suited for office spaces, halls, education structures and entertainment places.

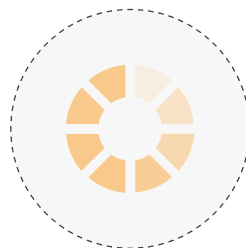

Color Fading

Assessment of colour fastness according to EN 1587 Assessed against the grey scale ISO 105-A02.

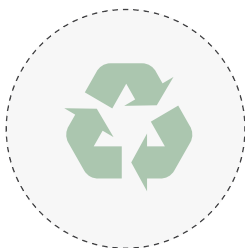

Recycled

The boards are made of 100% polyester PET, of which about 70% is recycled from drinking bottles.



Sustainability

Our PET Felt products contains post-consumer PET, does not contain any lead or tin, nor does it emit any (VOC) off gasses. It is recyclable and durable material, suitable for every environment.



Fire Reaction

Our products are manufactured in Israel according to the European fireproofing standard EN13501-I and American ASTM84 Class A.



Cleaning

Can be simply done using a damp cloth and vacuum cleaner.



SPECIFICATION

PRODUCT	Tile Size (mm)	Thickness (mm)
Slot	600x600	9
		12
		24

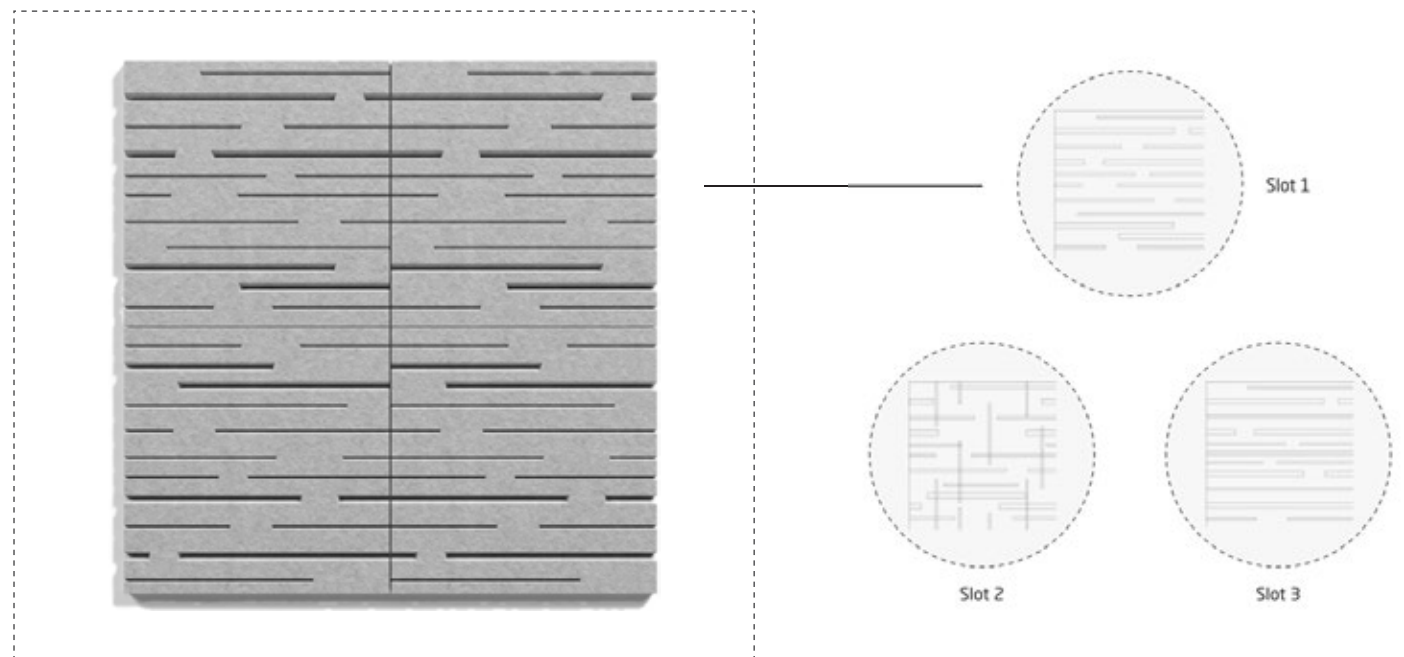

COLOR PALETTE

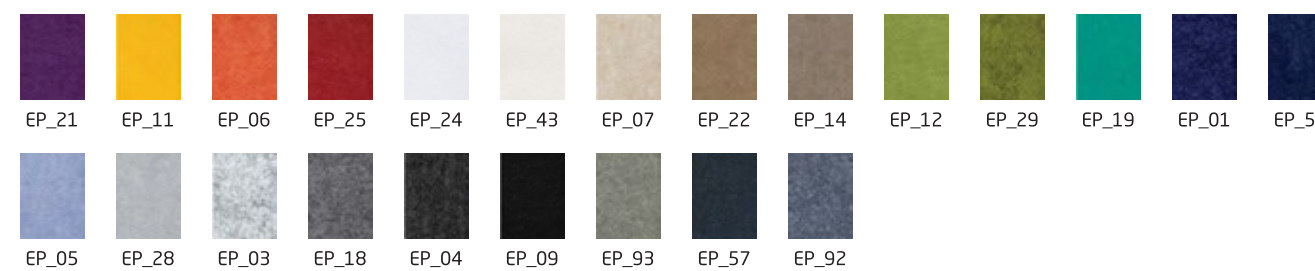

WOOD COLLECTION



INFORMATION

A selection of shades from an existing color palette. Can be painted in any desirable shade.

PROPERTIES



Acoustic Absorption

Our products poses a superb acoustic quality: NRC=0.4-0.95 in a variety of implementation applications that enable the creation of an ideal living environment, pleasant and of high quality, well suited for office spaces, halls, education structures and entertainment places.

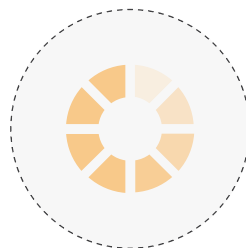

Color Fading

Assessment of colour fastness according to EN 1587 Assessed against the grey scale ISO 105-A02.

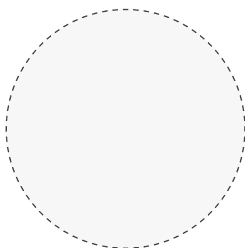

Recycled

The boards are made of 100% polyester PET, of which about 70% is recycled from drinking bottles.



Sustainability

Our PET Felt products contains post-consumer PET, does not contain any lead or tin, nor does it emit any (VOC) off gasses. It is recyclable and durable material, suitable for every environment.

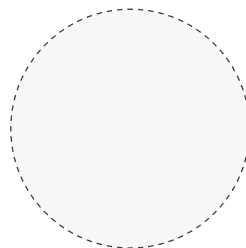

Fire Reaction

Our products are manufactured in Israel according to the European fireproofing standard EN13501-I and American ASTM84 Class A.



Cleaning

Can be simply done using a damp cloth and vacuum cleaner.

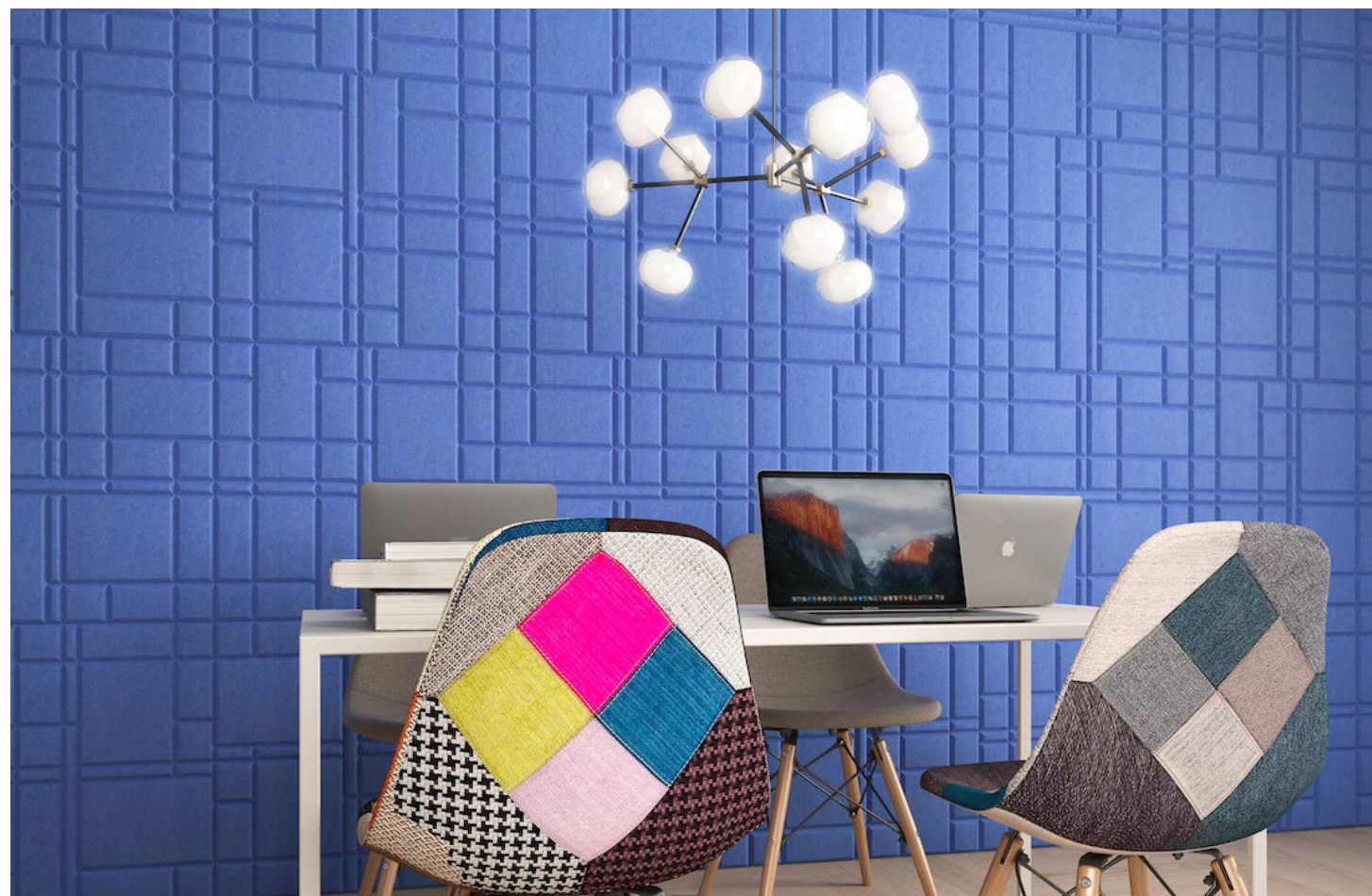

SPECIFICATION

PRODUCT	Tile Size (mm)	Thickness (mm)
Rec	600x600	9
		12
		24

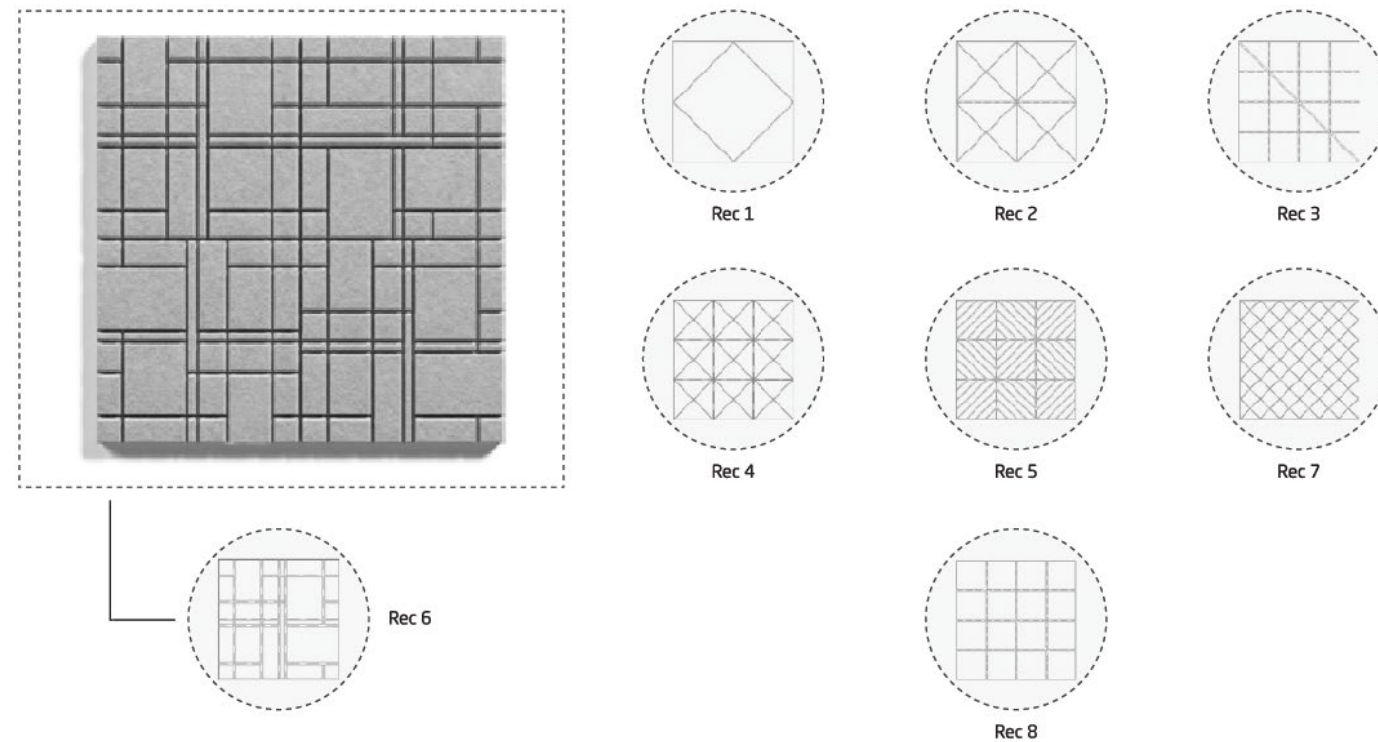

COLOR PALETTE

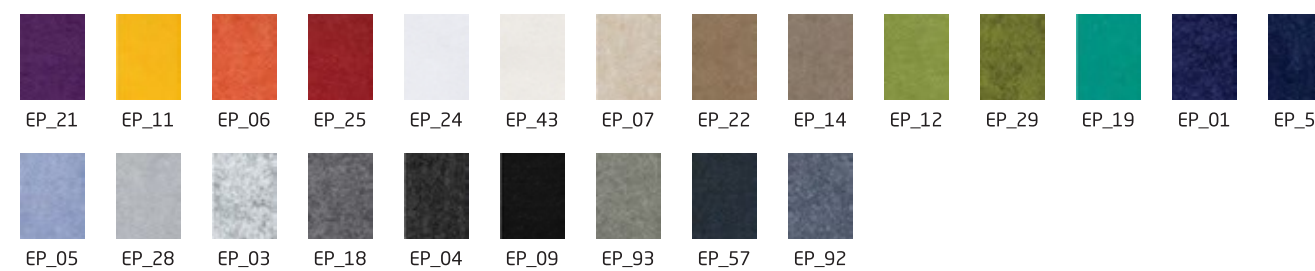

WOOD COLLECTION

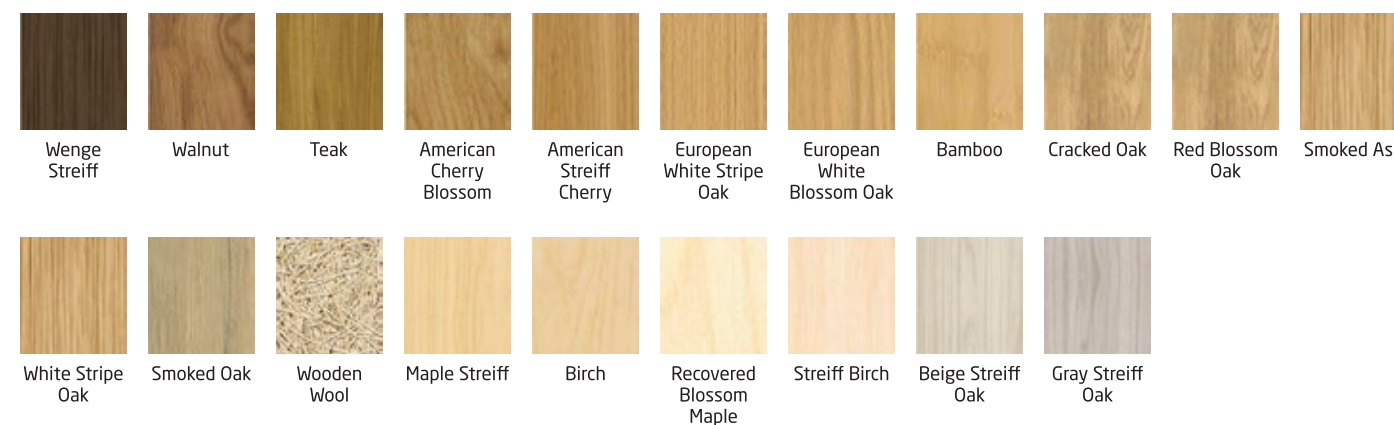

INFORMATION

A selection of shades from an existing color palette. Can be painted in any desirable shade.

PROPERTIES



Acoustic Absorption

Our products poses a superb acoustic quality: NRC=0.4-0.95 in a variety of implementation applications that enable the creation of an ideal living environment, pleasant and of high quality, well suited for office spaces, halls, education structures and entertainment places.

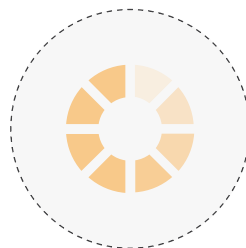

Color Fading

Assessment of colour fastness according to EN 1587 Assessed against the grey scale ISO 105-A02.

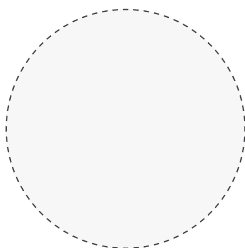

Recycled

The boards are made of 100% polyester PET, of which about 70% is recycled from drinking bottles.



Sustainability

Our PET Felt products contains post-consumer PET, does not contain any lead or tin, nor does it emit any (VOC) off gasses. It is recyclable and durable material, suitable for every environment.

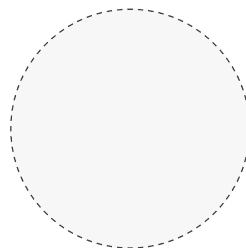

Fire Reaction

Our products are manufactured in Israel according to the European fireproofing standard EN13501-I and American ASTM84 Class A.



Cleaning

Can be simply done using a damp cloth and vacuum cleaner.



SPECIFICATION

PRODUCT	Tile Size (mm)	Thickness (mm)
Geo	600x600	9
		12
		24

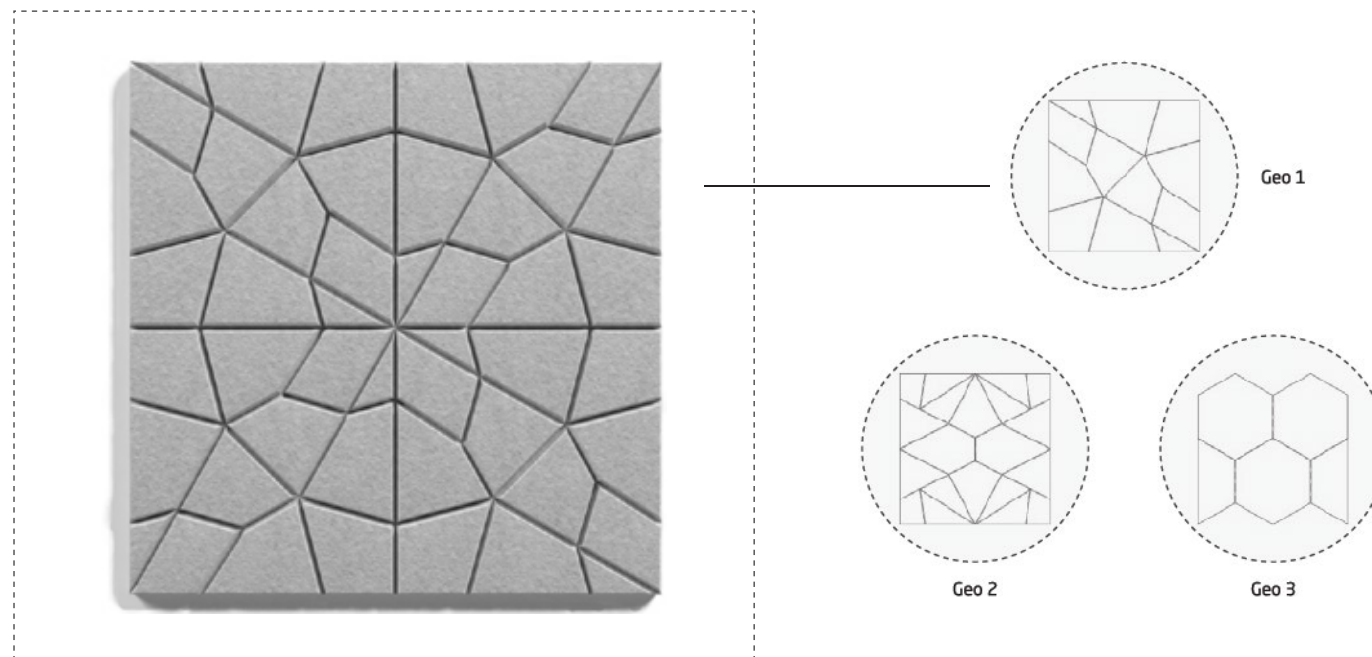

COLOR PALETTE

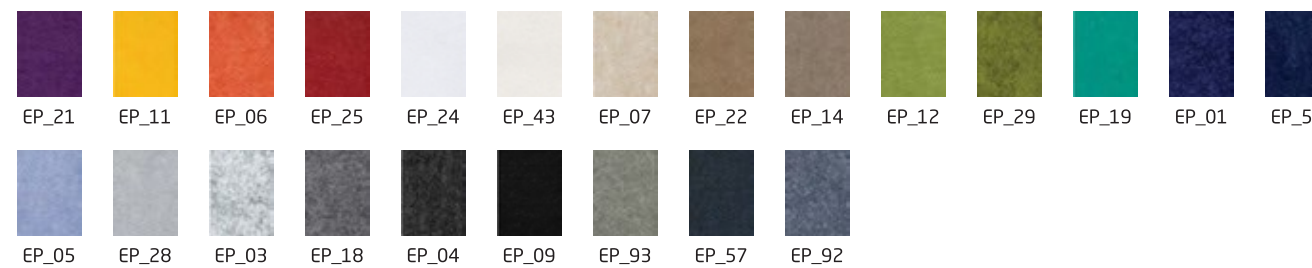

WOOD COLLECTION

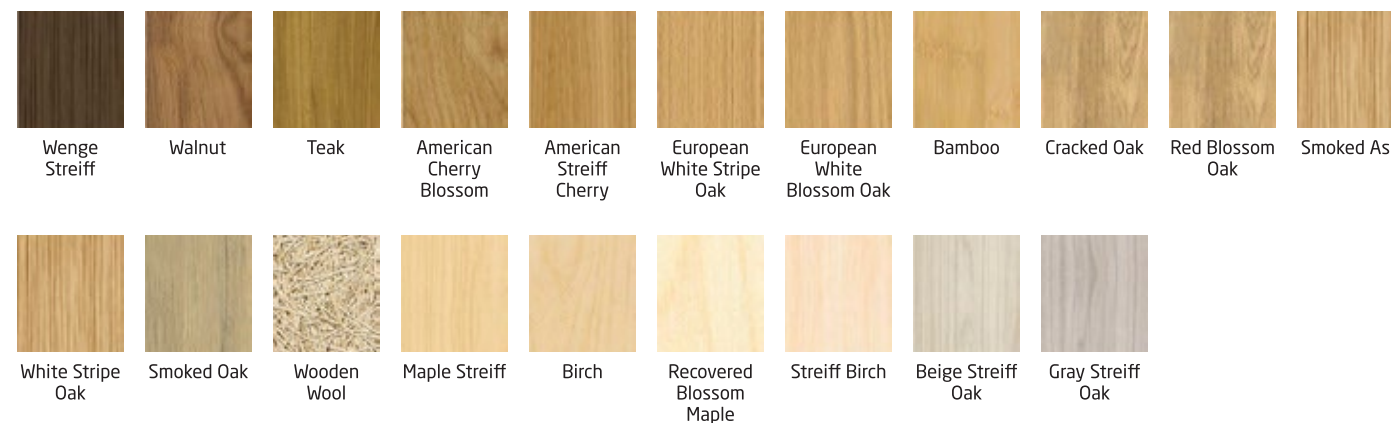

INFORMATION

A selection of combining patterns that enable a large number of combinations. A selection of shades from an existing color palette. Can be painted in any desirable shade.

PROPERTIES



Acoustic Absorption

Our products poses a superb acoustic quality: NRC=0.4-0.95 in a variety of implementation applications that enable the creation of an ideal living environment, pleasant and of high quality, well suited for office spaces, halls, education structures and entertainment places.

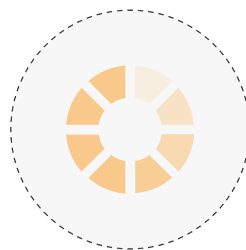

Color Fading

Assessment of colour fastness according to EN 1587 Assessed against the grey scale ISO 105-A02.

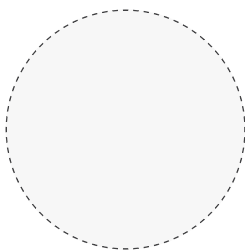

Recycled

The boards are made of 100% polyester PET, of which about 70% is recycled from drinking bottles.



Sustainability

Our PET Felt products contains post-consumer PET, does not contain any lead or tin, nor does it emit any (VOC) off gasses. It is recyclable and durable material, suitable for every environment.

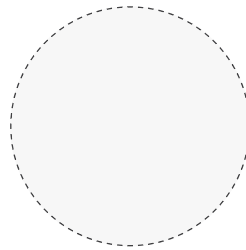

Fire Reaction

Our products are manufactured in Israel according to the European fireproofing standard EN13501-1 and American ASTM84 Class A.



Cleaning

Can be simply done using a damp cloth and vacuum cleaner.



SPECIFICATION

PRODUCT	Tile Size (mm)	Thickness (mm)
Line	600x600	9
		12
		24

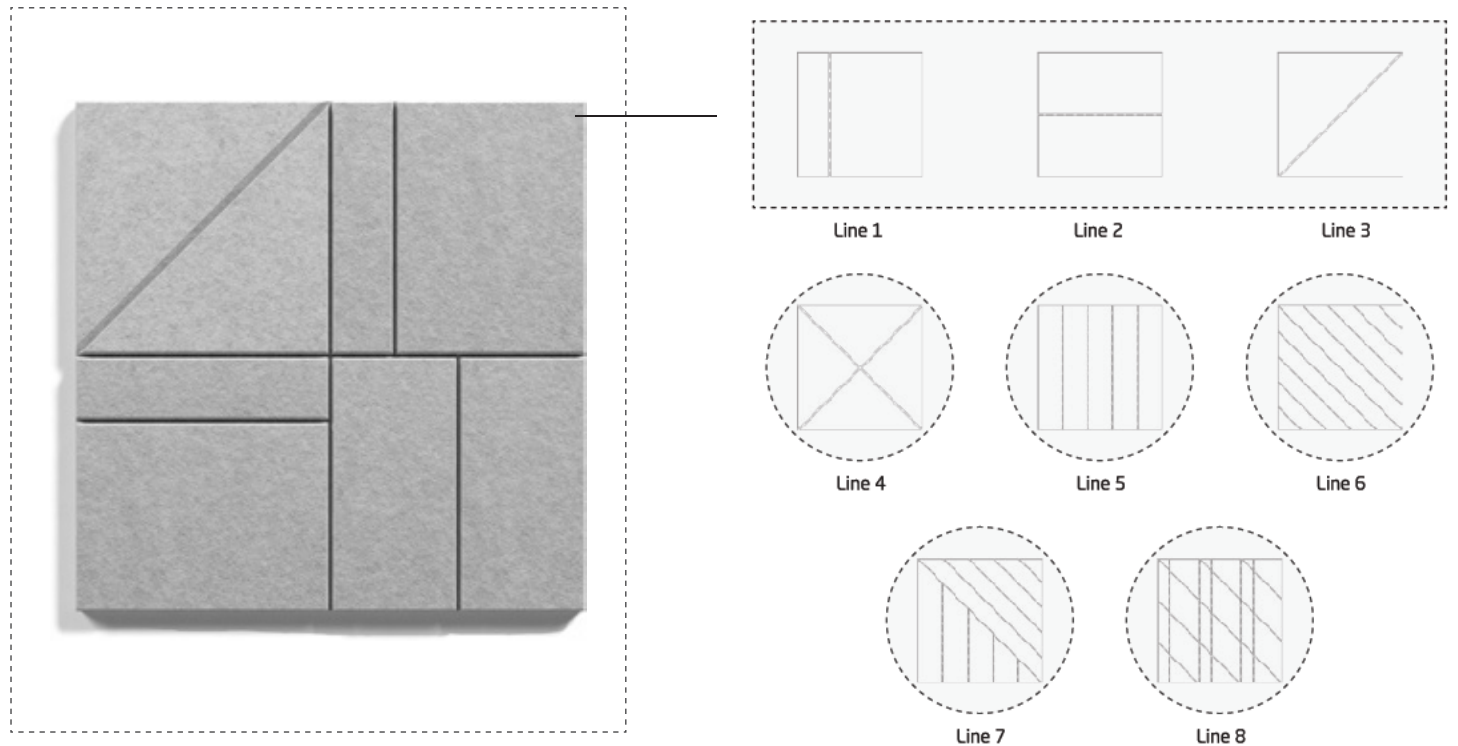

COLOR PALETTE

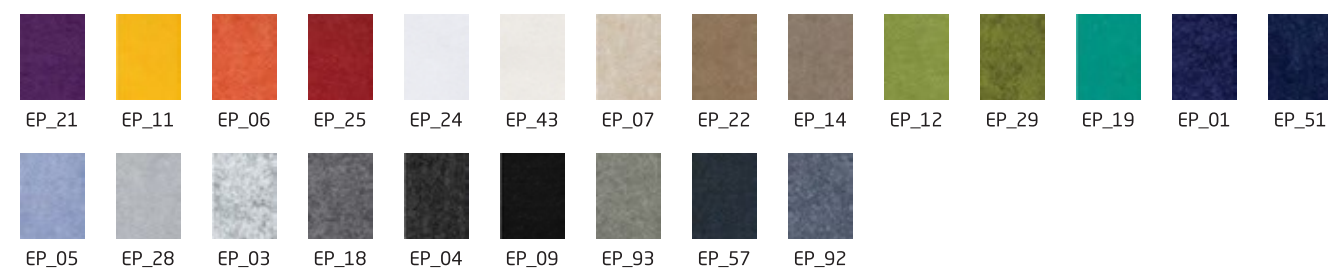

WOOD COLLECTION





Chapter

03

 **integra**[®]
FELTLINE CEILING SYSTEMS

Shaped

- Cube
- Hex
- Bricks
- Train

INFORMATION

Square shapes tile.

PROPERTIES



Acoustic Absorption

Our products poses a superb acoustic quality: NRC=0.4-0.95 in a variety of implementation applications that enable the creation of an ideal living environment, pleasant and of high quality, well suited for office spaces, halls, education structures and entertainment places.

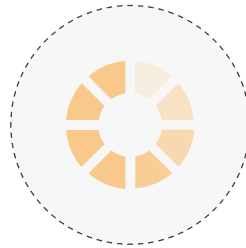

Color Fading

Assessment of colour fastness according to EN 1587 Assessed against the grey scale ISO 105-A02.



Recycled

The boards are made of 100% polyester PET, of which about 70% is recycled from drinking bottles.



Sustainability

Our PET Felt products contains post-consumer PET, does not contain any lead or tin, nor does it emit any (VOC) off gasses. It is recyclable and durable material, suitable for every environment.



Fire Reaction

Our products are manufactured in Israel according to the European fireproofing standard EN13501-I and American ASTM84 Class A.



Cleaning

Can be simply done using a damp cloth and vacuum cleaner.



SPECIFICATION

PRODUCT	Tile Size (mm)	Thickness (mm)
Cube	300x300	9
	400x400	12
	600x600	24

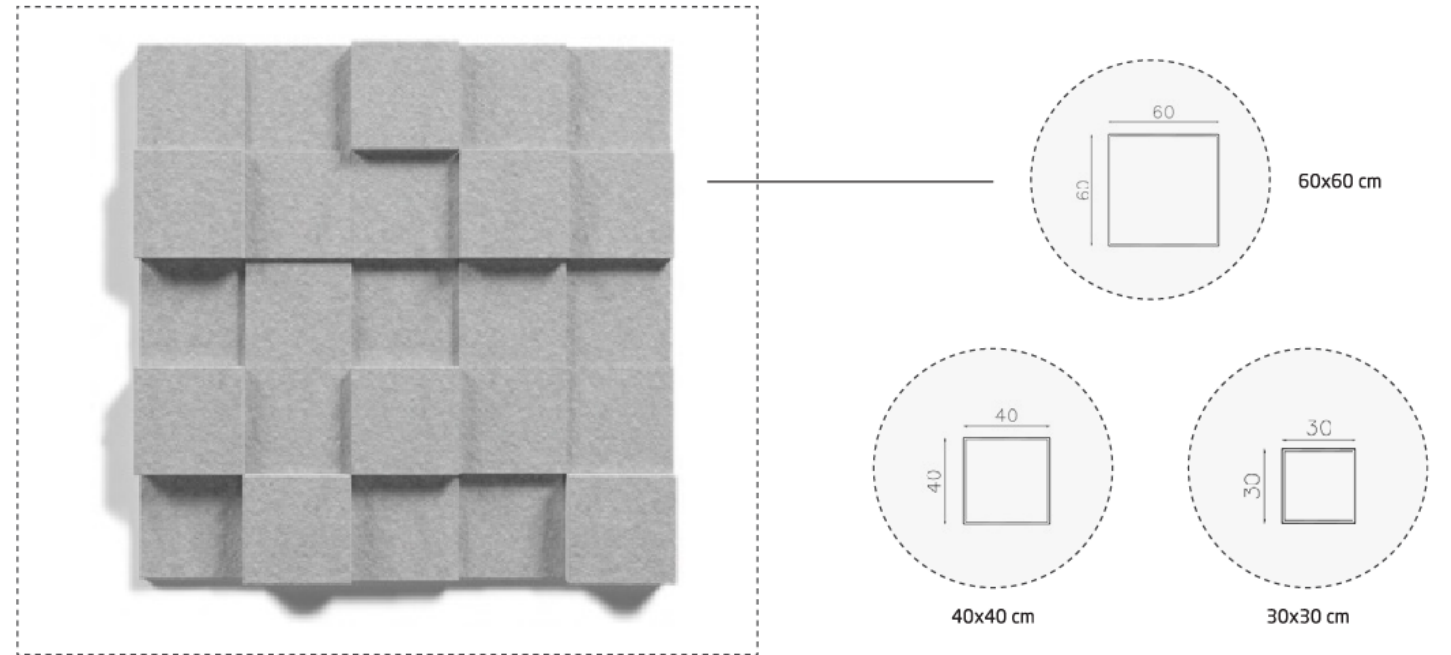

COLOR PALETTE

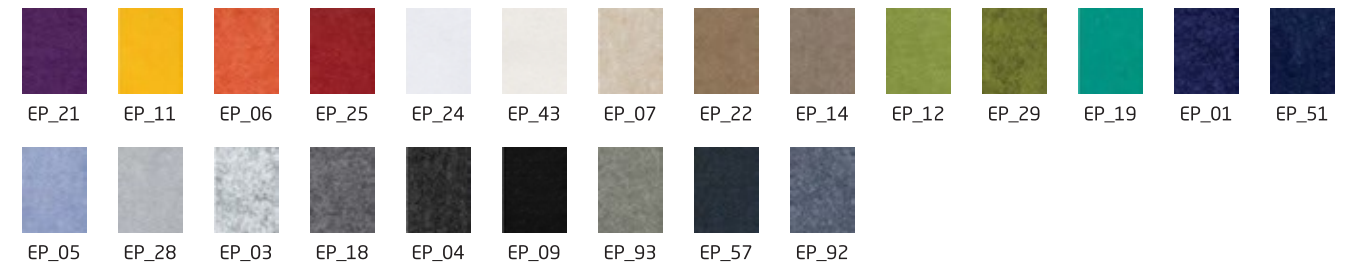

WOOD COLLECTION



INFORMATION

Hexagonal shaped geometric tile. Beveled edge along the tile's entire circumference. The tiles cling to each other in order to create assembly compositions.

PROPERTIES



Acoustic Absorption

Our products poses a superb acoustic quality: NRC=0.4-0.95 in a variety of implementation applications that enable the creation of an ideal living environment, pleasant and of high quality, well suited for office spaces, halls, education structures and entertainment places.

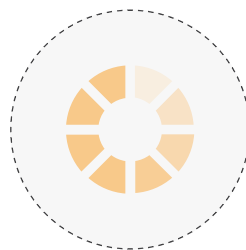

Color Fading

Assessment of colour fastness according to EN 1587 Assessed against the grey scale ISO 105-A02.

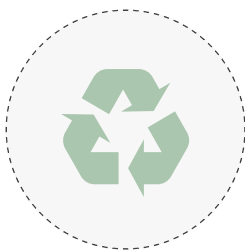

Recycled

The boards are made of 100% polyester PET, of which about 70% is recycled from drinking bottles.



Sustainability

Our PET Felt products contains post-consumer PET, does not contain any lead or tin, nor does it emit any (VOC) off gasses. It is recyclable and durable material, suitable for every environment.



Fire Reaction

Our products are manufactured in Israel according to the European fireproofing standard EN13501-1 and American ASTM84 Class A.



Cleaning

Can be simply done using a damp cloth and vacuum cleaner.



SPECIFICATION

PRODUCT	Tile Size (mm)	Thickness (mm)
Hex	470/400	9
	600/520	12
		24



COLOR PALETTE

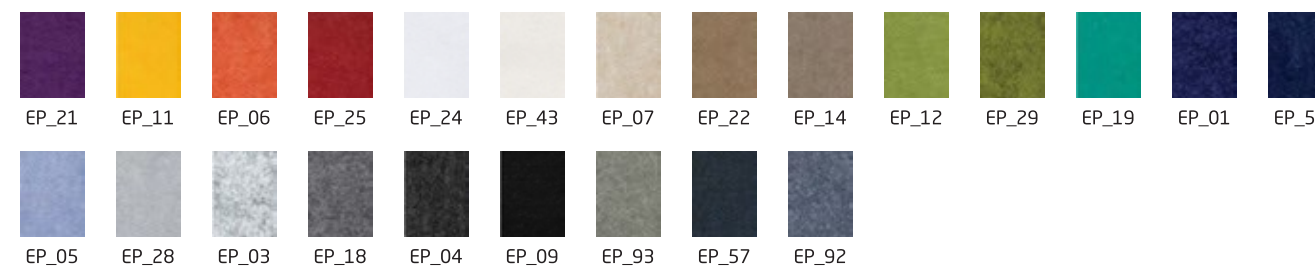

WOOD COLLECTION

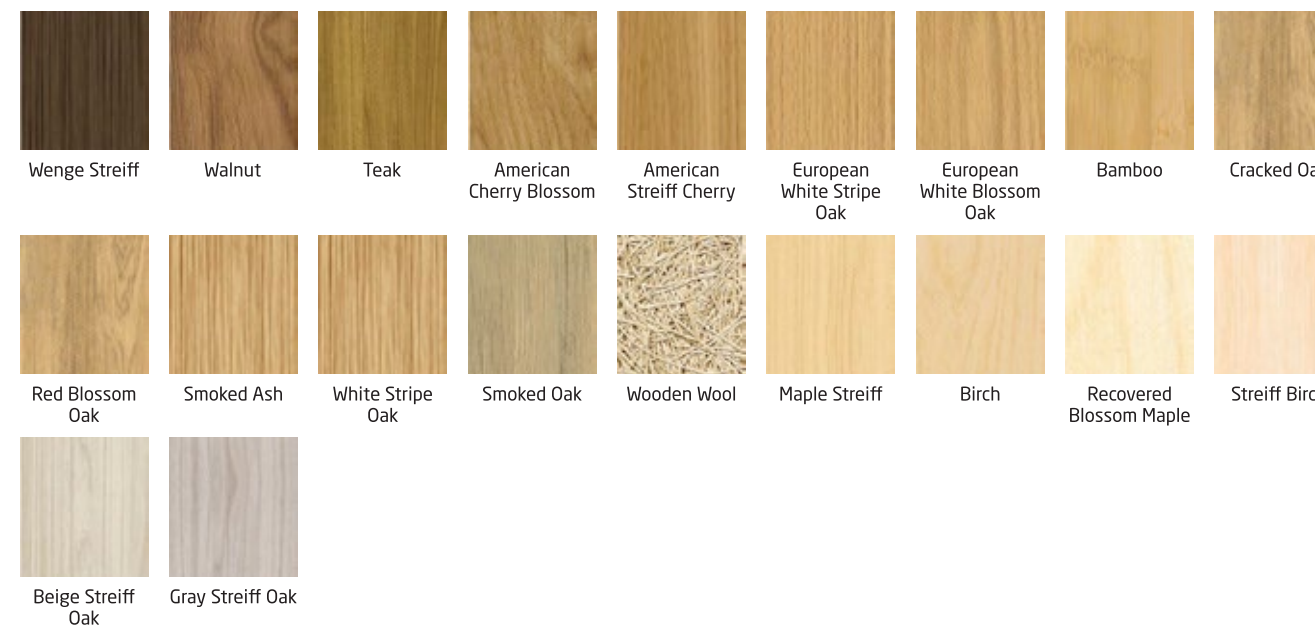

INFORMATION

A rectangle shaped tile. Beveled edge along the tile's two long sides. Several assemblies compositions can be created.

PROPERTIES



Acoustic Absorption

Our products poses a superb acoustic quality: NRC=0.4-0.95 in a variety of implementation applications that enable the creation of an ideal living environment, pleasant and of high quality, well suited for office spaces, halls, education structures and entertainment places.

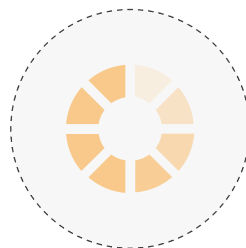

Color Fading

Assessment of colour fastness according to EN 1587 Assessed against the grey scale ISO 105-A02.

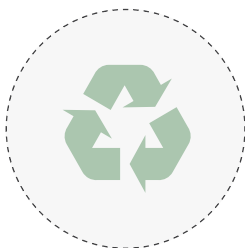

Recycled

The boards are made of 100% polyester PET, of which about 70% is recycled from drinking bottles.



Sustainability

Our PET Felt products contains post-consumer PET, does not contain any lead or tin, nor does it emit any (VOC) off gasses. It is recyclable and durable material, suitable for every environment.



Fire Reaction

Our products are manufactured in Israel according to the European fireproofing standard EN13501-I and American ASTM84 Class A.



Cleaning

Can be simply done using a damp cloth and vacuum cleaner.



SPECIFICATION

PRODUCT	Tile Size (mm)	Thickness (mm)
Bricks	400/150	9
	400/200	12
	600/300	24

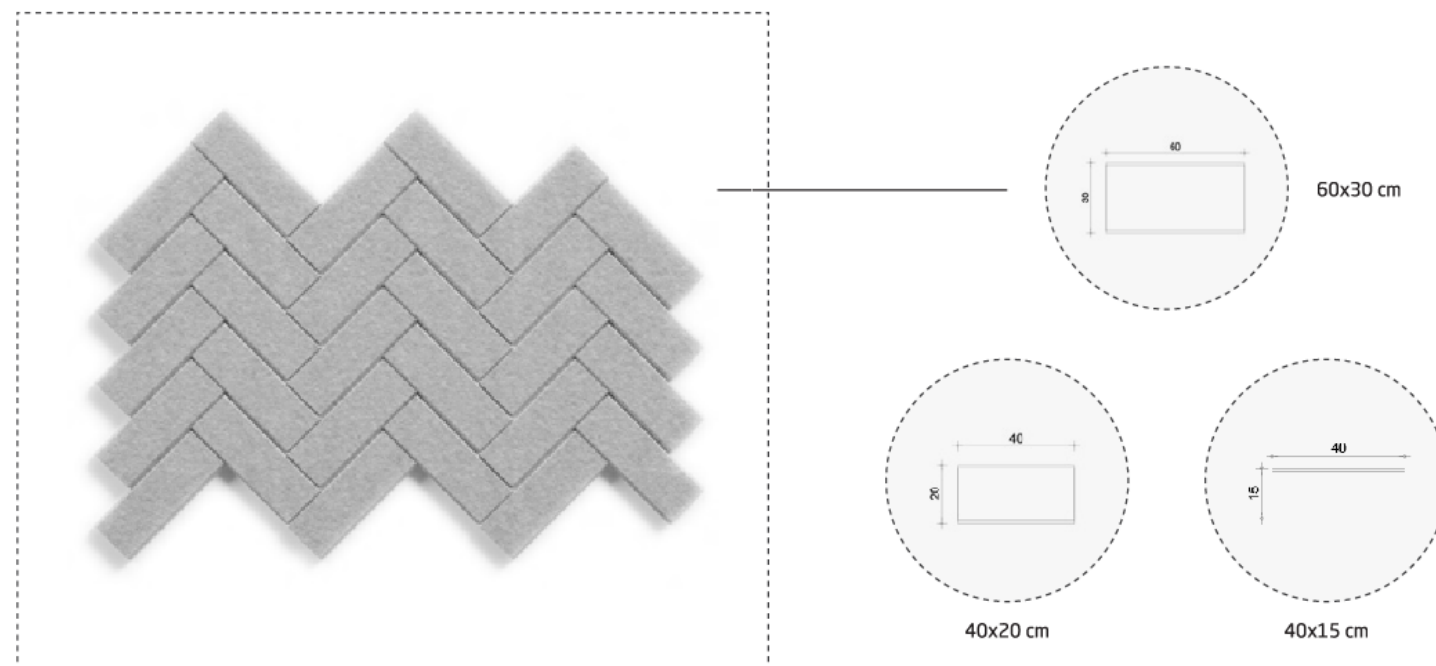

COLOR PALETTE

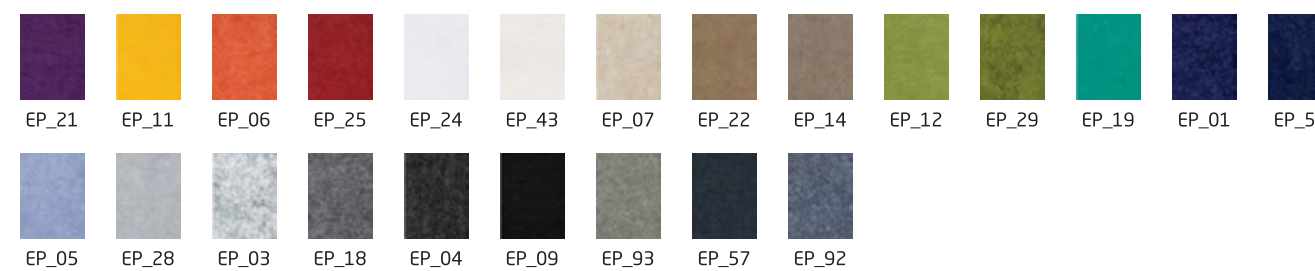

WOOD COLLECTION



INFORMATION

A triangle shaped tile - Equilateral triangle. Beveled edge along the tile's entire circumference.

PROPERTIES



Acoustic Absorption

Our products poses a superb acoustic quality: NRC=0.4-0.95 in a variety of implementation applications that enable the creation of an ideal living environment, pleasant and of high quality, well suited for office spaces, halls, education structures and entertainment places.

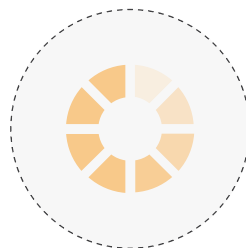

Color Fading

Assessment of colour fastness according to EN 1587 Assessed against the grey scale ISO 105-A02.

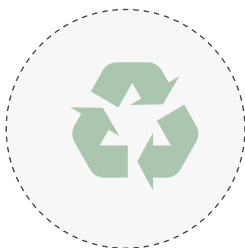

Recycled

The boards are made of 100% polyester PET, of which about 70% is recycled from drinking bottles.



Sustainability

Our PET Felt products contains post-consumer PET, does not contain any lead or tin, nor does it emit any (VOC) off gasses. It is recyclable and durable material, suitable for every environment.



Fire Reaction

Our products are manufactured in Israel according to the European fireproofing standard EN13501-I and American ASTM84 Class A.



Cleaning

Can be simply done using a damp cloth and vacuum cleaner.



SPECIFICATION

PRODUCT	Tile Size (mm)	Thickness (mm)
Train	300/300	9
	400/400	12
	600/600	24

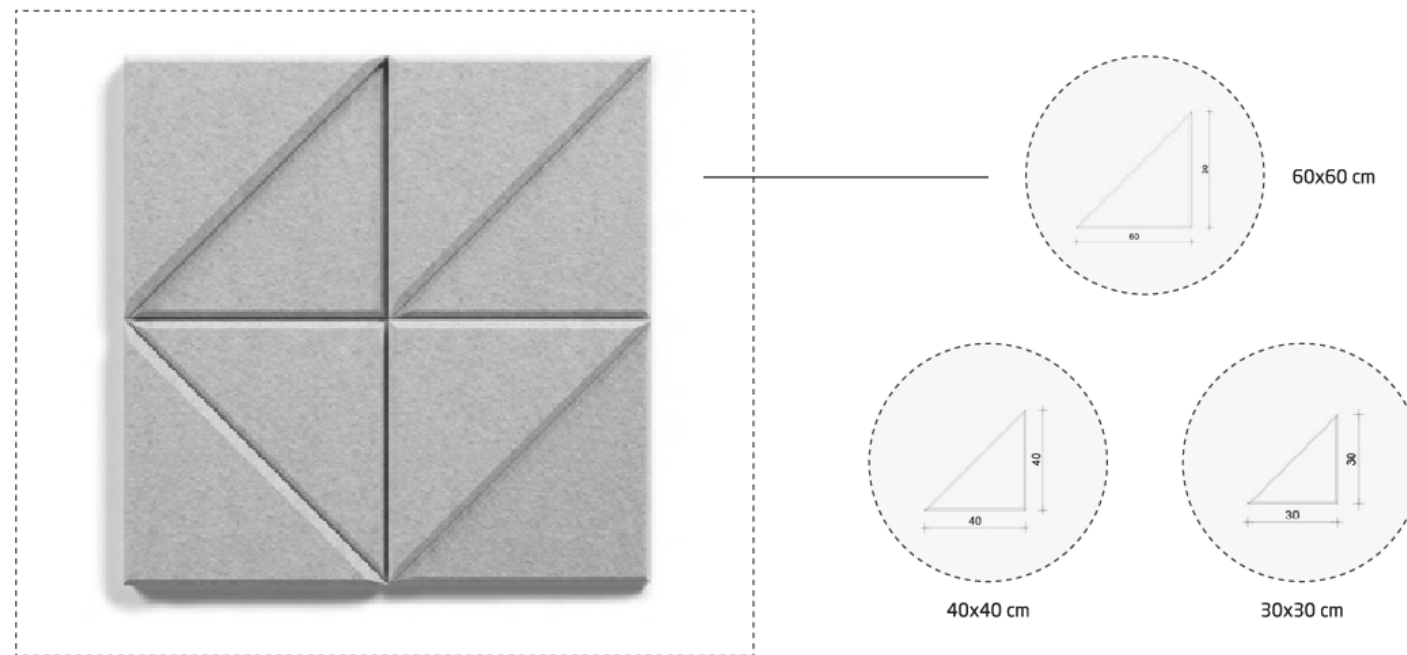

COLOR PALETTE

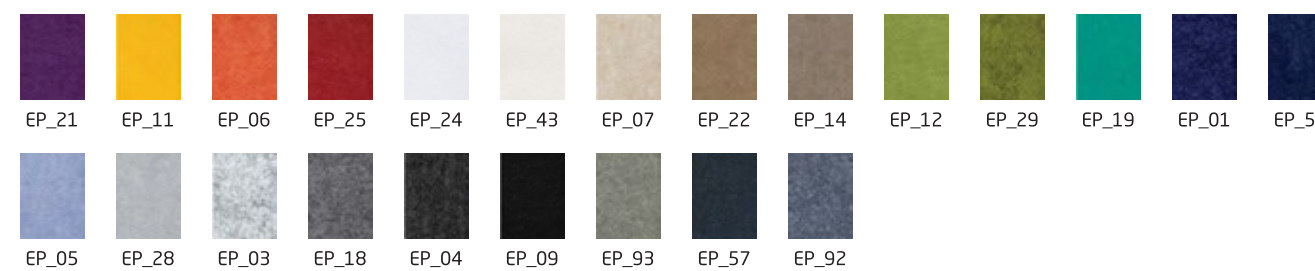

WOOD COLLECTION





Chapter

04

 **integra**[®]
FELTLINE CEILING SYSTEMS

Acoustic Partitions

- Urban
- Slot
- Hives
- Drops
- Books

INFORMATION

The hanging tiles series, grooved according to a pattern, that act as spaces dividers. They can be permanently hung or mobile on a rails.

PROPERTIES



Acoustic Absorption

Our products poses a superb acoustic quality: NRC=0.4-0.95 in a variety of implementation applications that enable the creation of an ideal living environment, pleasant and of high quality, well suited for office spaces, halls, education structures and entertainment places.

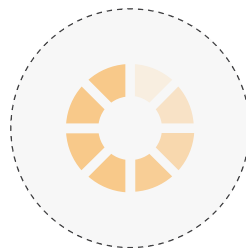

Color Fading

Assessment of colour fastness according to EN 1587 Assessed against the grey scale ISO 105-A02.



Recycled

The boards are made of 100% polyester PET, of which about 70% is recycled from drinking bottles.



Sustainability

Our PET Felt Products contains post-consumer PET, does not contain any lead or tin, nor does it emit any (VOC) off gasses. It is recyclable and durable material, suitable for every environment.



Fire Reaction

Our products are manufactured in Israel according to the European fireproofing standard EN13501-I and American ASTM84 Class A.



Cleaning

Can be simply done using a damp cloth and vacuum cleaner.



SPECIFICATION

PRODUCT	Width (mm)	Height (mm)	Thickness (mm)
Urban	1200	2400	12
		2800	24

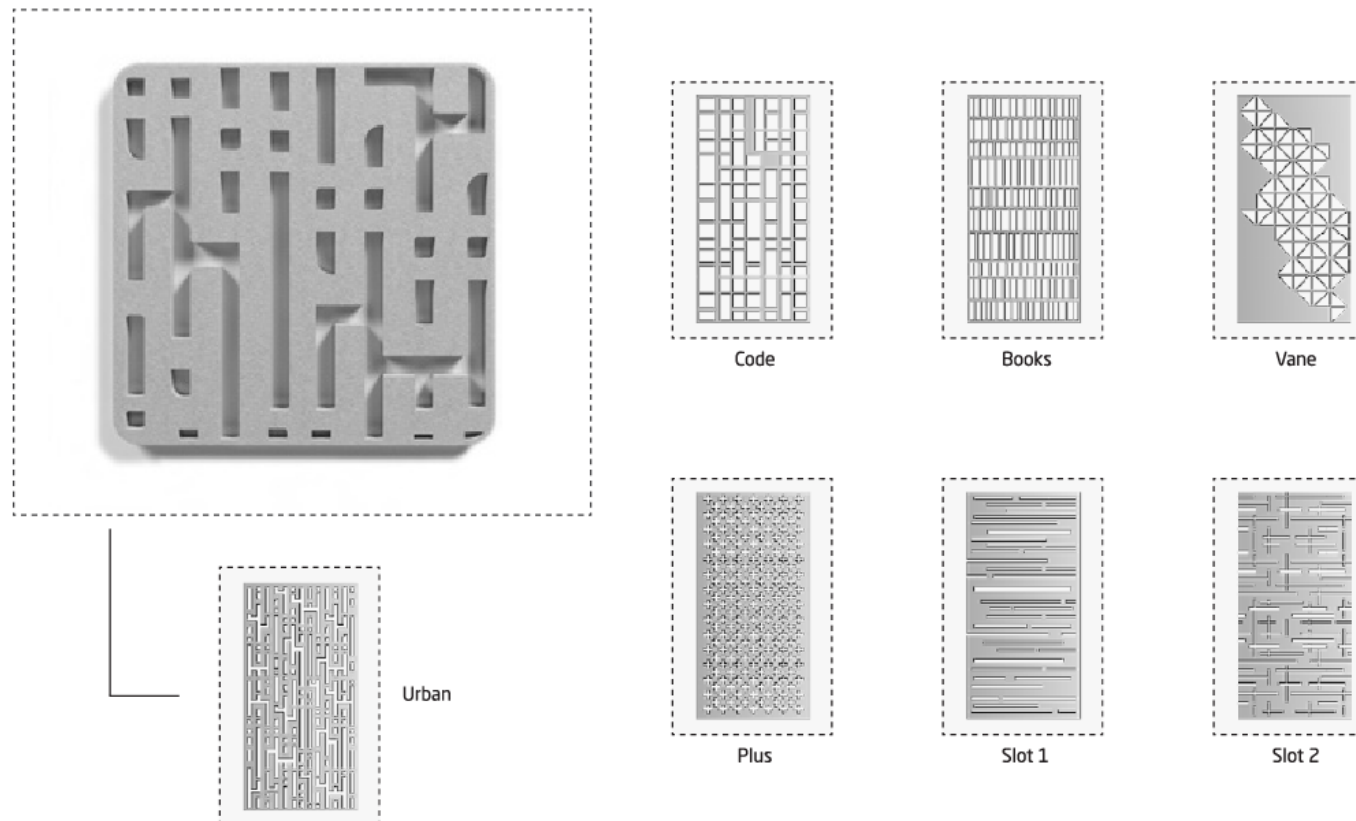

COLOR PALETTE

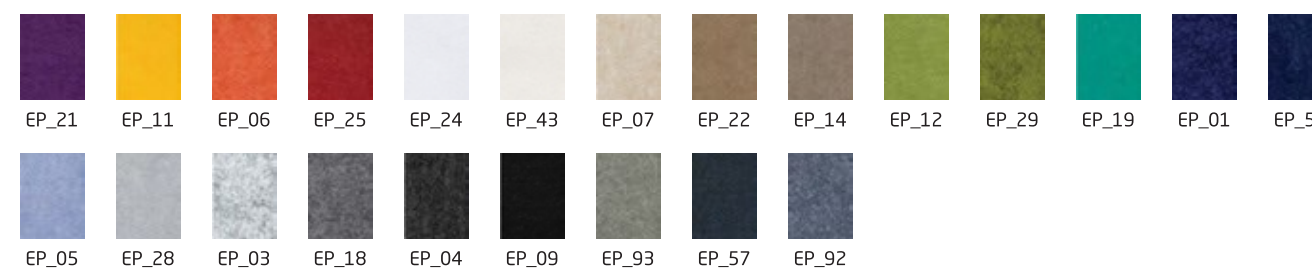

WOOD COLLECTION



INFORMATION

The hanging tiles series, grooved according to a pattern, that act as spaces dividers. They can be permanently hung or mobile on a rails.

PROPERTIES



Acoustic Absorption

Our products poses a superb acoustic quality: NRC=0.4-0.95 in a variety of implementation applications that enable the creation of an ideal living environment, pleasant and of high quality, well suited for office spaces, halls, education structures and entertainment places.

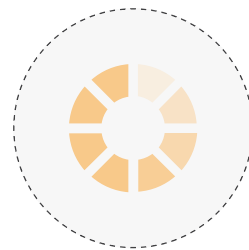

Color Fading

Assessment of colour fastness according to EN 1587 Assessed against the grey scale ISO 105-A02.

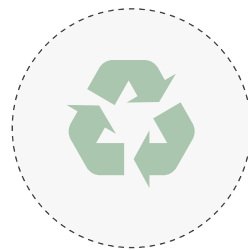

Recycled

The boards are made of 100% polyester PET, of which about 70% is recycled from drinking bottles.



Sustainability

Our PET Felt products contains post-consumer PET, does not contain any lead or tin, nor does it emit any (VOC) off gasses. It is recyclable and durable material, suitable for every environment.



Fire Reaction

Our products are manufactured in Israel according to the European fireproofing standard EN13501-I and American ASTM84 Class A.



Cleaning

Can be simply done using a damp cloth and vacuum cleaner.

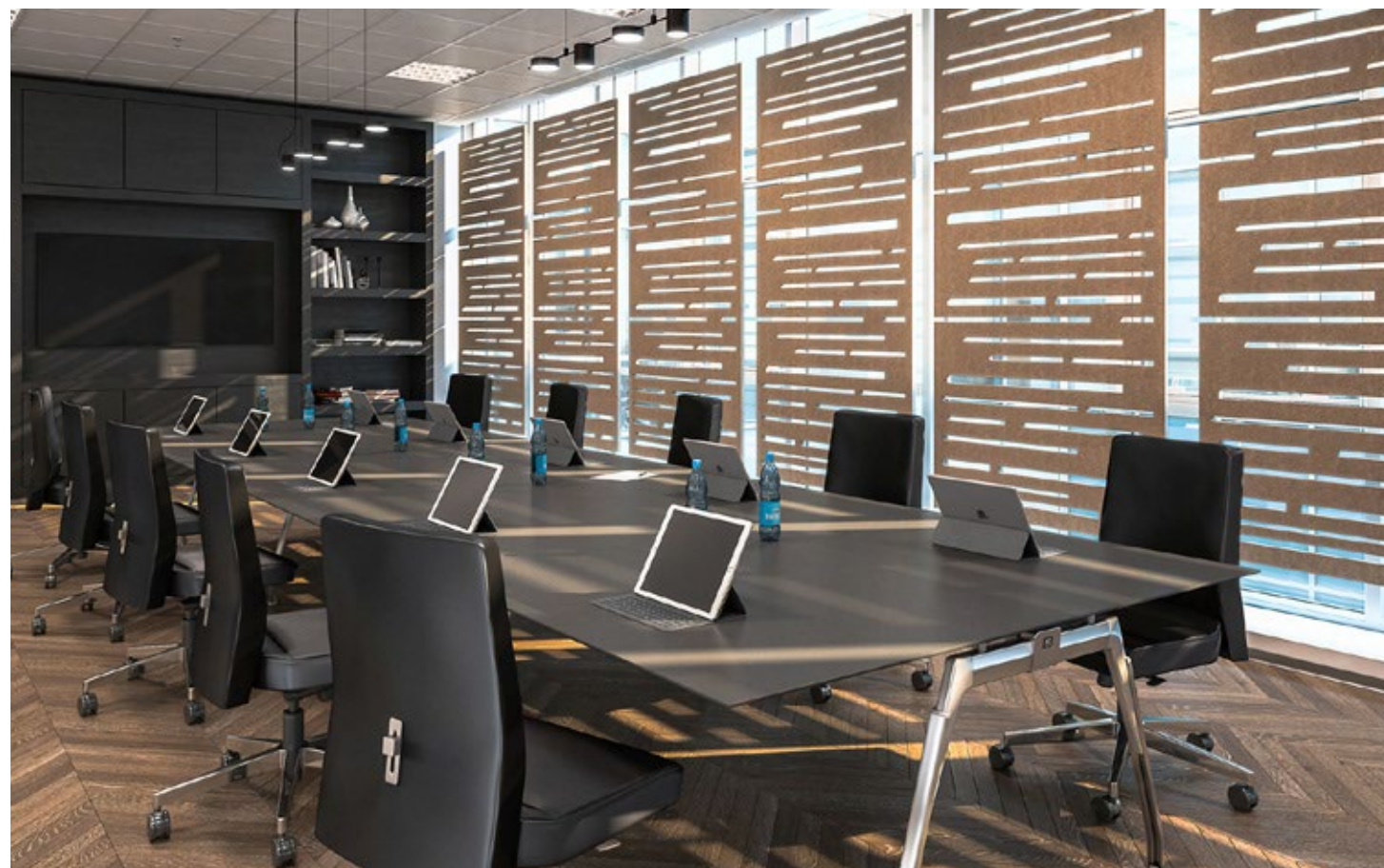

SPECIFICATION

PRODUCT	Width (mm)	Height (mm)	Thickness (mm)
Slots	1200	2400	12
		2800	24

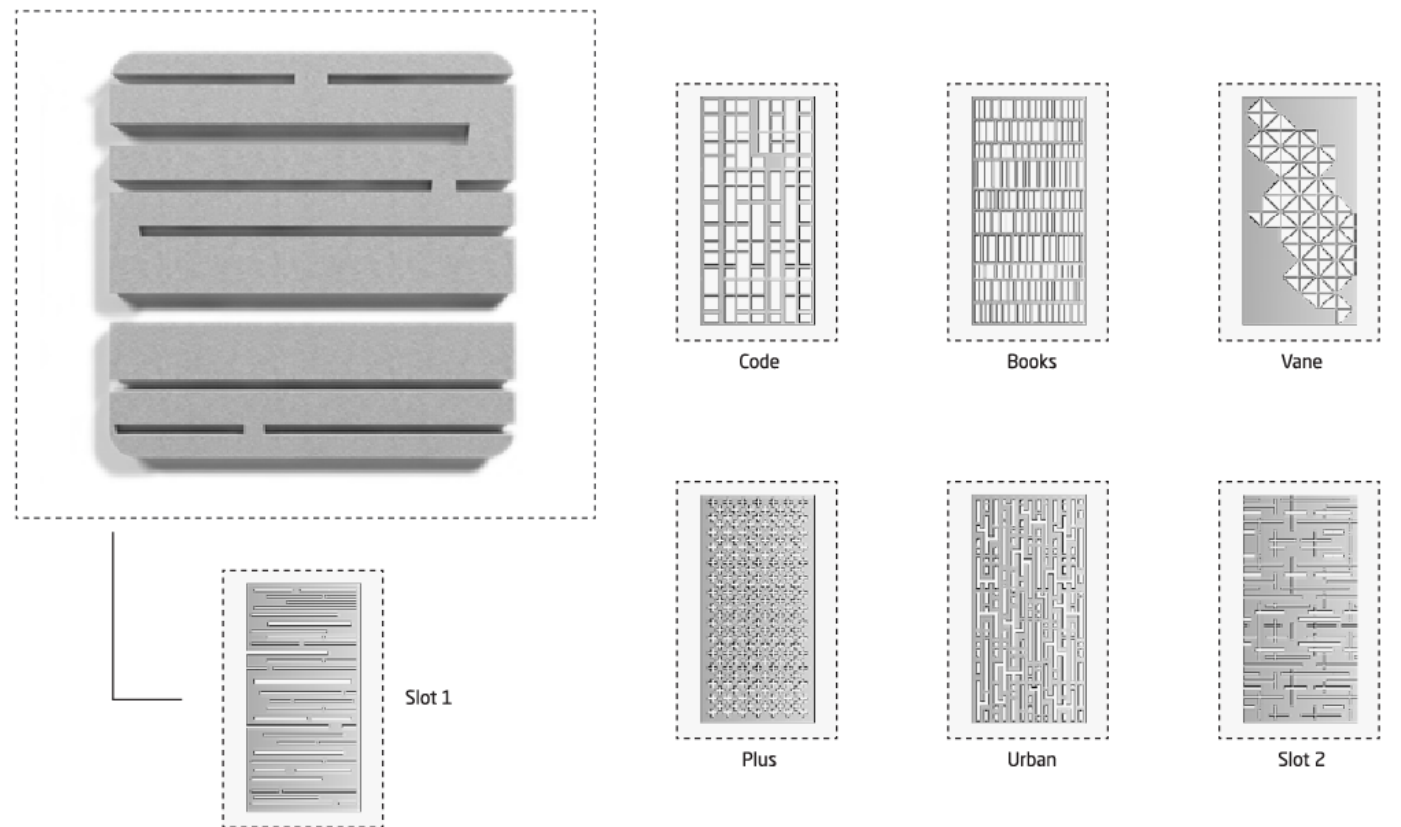

COLOR PALETTE

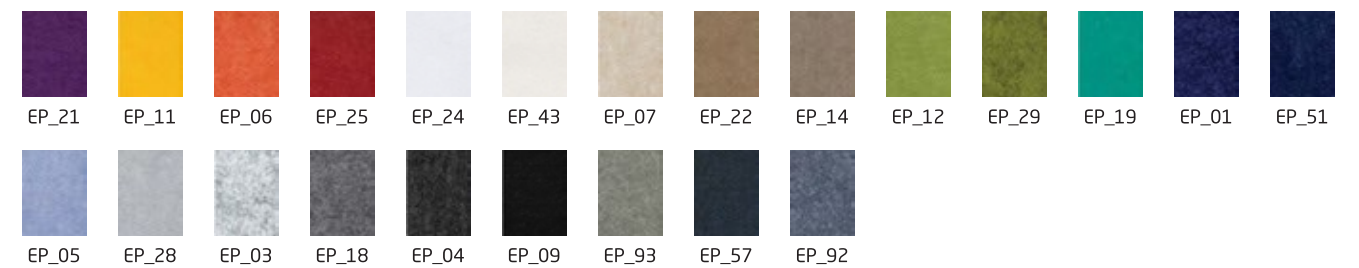

WOOD COLLECTION



INFORMATION

The hanging tiles series, grooved according to a pattern, that act as spaces dividers. They can be permanently hung or mobile on a rails.

PROPERTIES



Acoustic Absorption

Our products poses a superb acoustic quality: NRC=0.4-0.95 in a variety of implementation applications that enable the creation of an ideal living environment, pleasant and of high quality, well suited for office spaces, halls, education structures and entertainment places.

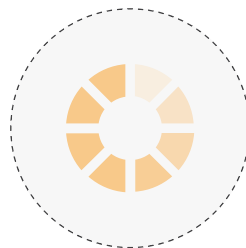

Color Fading

Assessment of colour fastness according to EN 1587 Assessed against the grey scale ISO 105-A02.

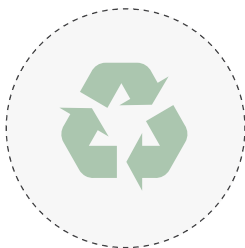

Recycled

The boards are made of 100% polyester PET, of which about 70% is recycled from drinking bottles.



Sustainability

Our PET Felt products contains post-consumer PET, does not contain any lead or tin, nor does it emit any (VOC) off gasses. It is recyclable and durable material, suitable for every environment.



Fire Reaction

Our products are manufactured in Israel according to the European fireproofing standard EN13501-I and American ASTM84 Class A.



Cleaning

Can be simply done using a damp cloth and vacuum cleaner.



SPECIFICATION

PRODUCT	Width (mm)	Height (mm)	Thickness (mm)
Hive	1200	2400	12
		2800	24

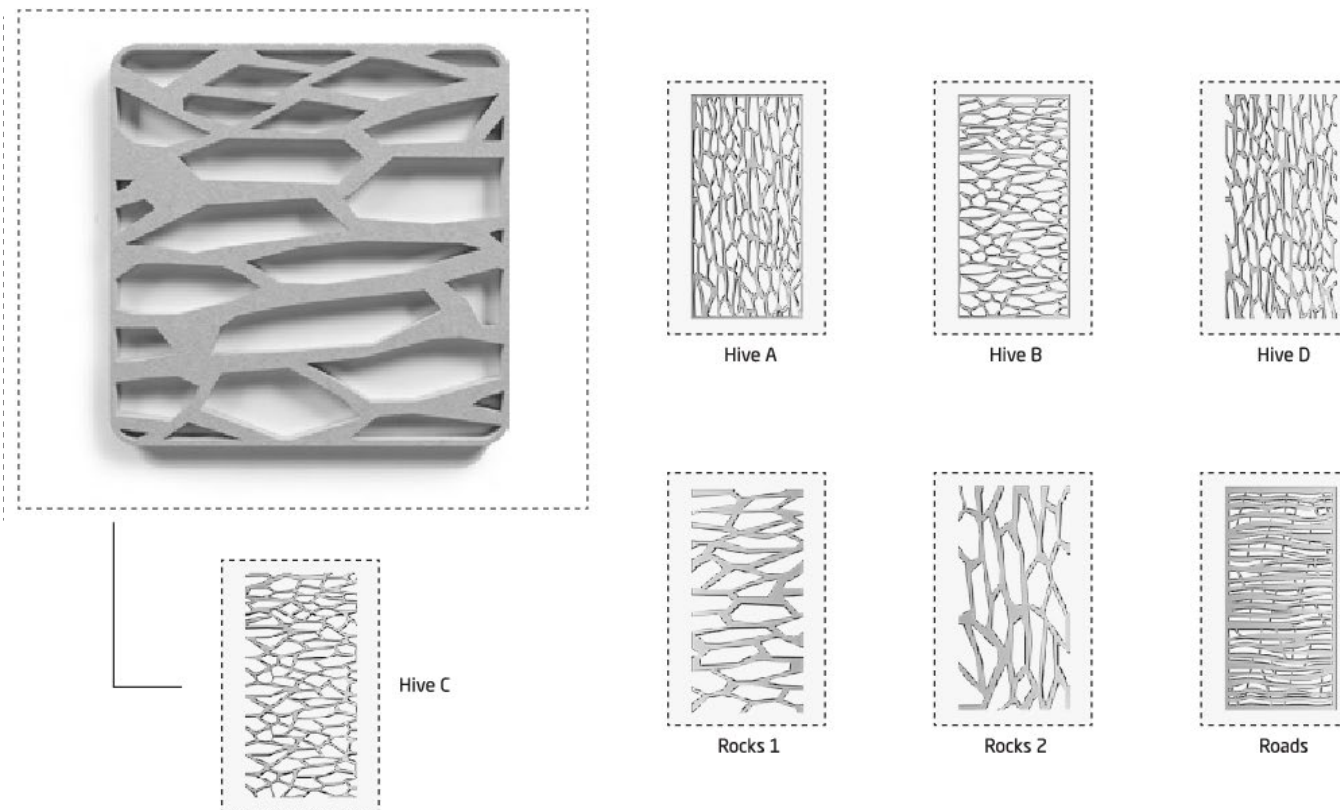

COLOR PALETTE

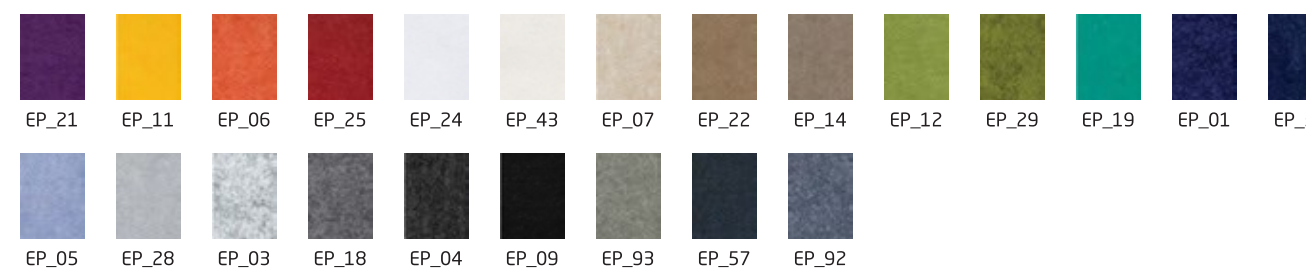

WOOD COLLECTION

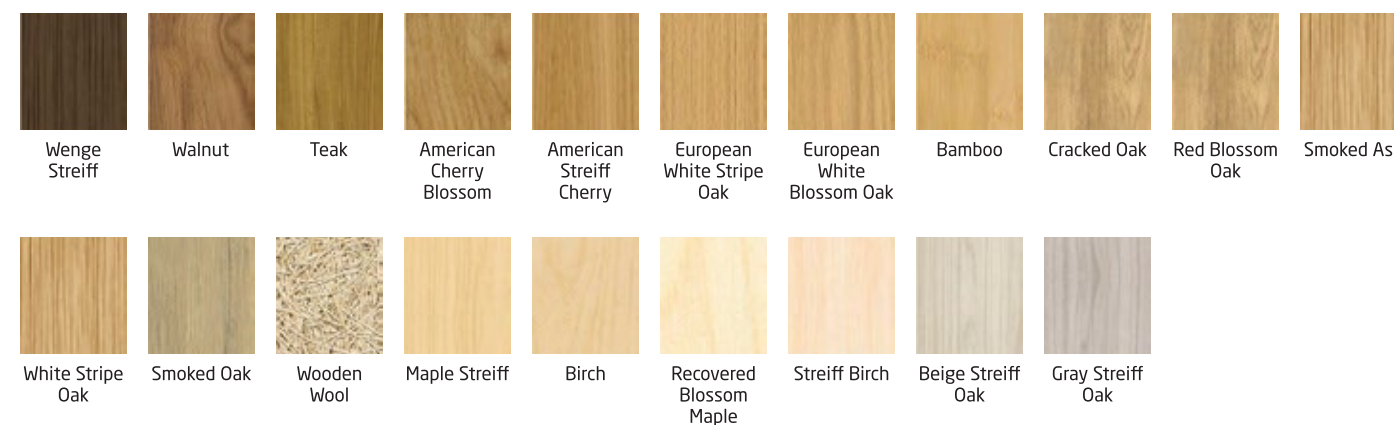

INFORMATION

The hanging tiles series, grooved according to a pattern, that act as spaces dividers. They can be permanently hung or mobile on a rails.

PROPERTIES



Acoustic Absorption

Our products poses a superb acoustic quality: NRC=0.4-0.95 in a variety of implementation applications that enable the creation of an ideal living environment, pleasant and of high quality, well suited for office spaces, halls, education structures and entertainment places.

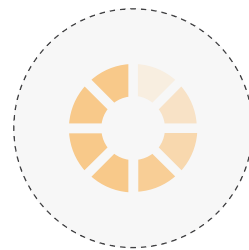

Color Fading

Assessment of colour fastness according to EN 1587 Assessed against the grey scale ISO 105-A02.

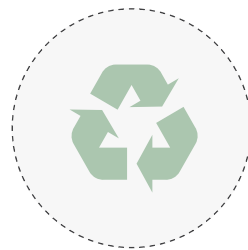

Recycled

The boards are made of 100% polyester PET, of which about 70% is recycled from drinking bottles.



Sustainability

Our PET Felt products contains post-consumer PET, does not contain any lead or tin, nor does it emit any (VOC) off gasses. It is recyclable and durable material, suitable for every environment.



Fire Reaction

Our products are manufactured in Israel according to the European fireproofing standard EN13501-I and American ASTM84 Class A.



Cleaning

Can be simply done using a damp cloth and vacuum cleaner.



SPECIFICATION

PRODUCT	Width (mm)	Height (mm)	Thickness (mm)
Drops	1200	2400	12
		2800	24

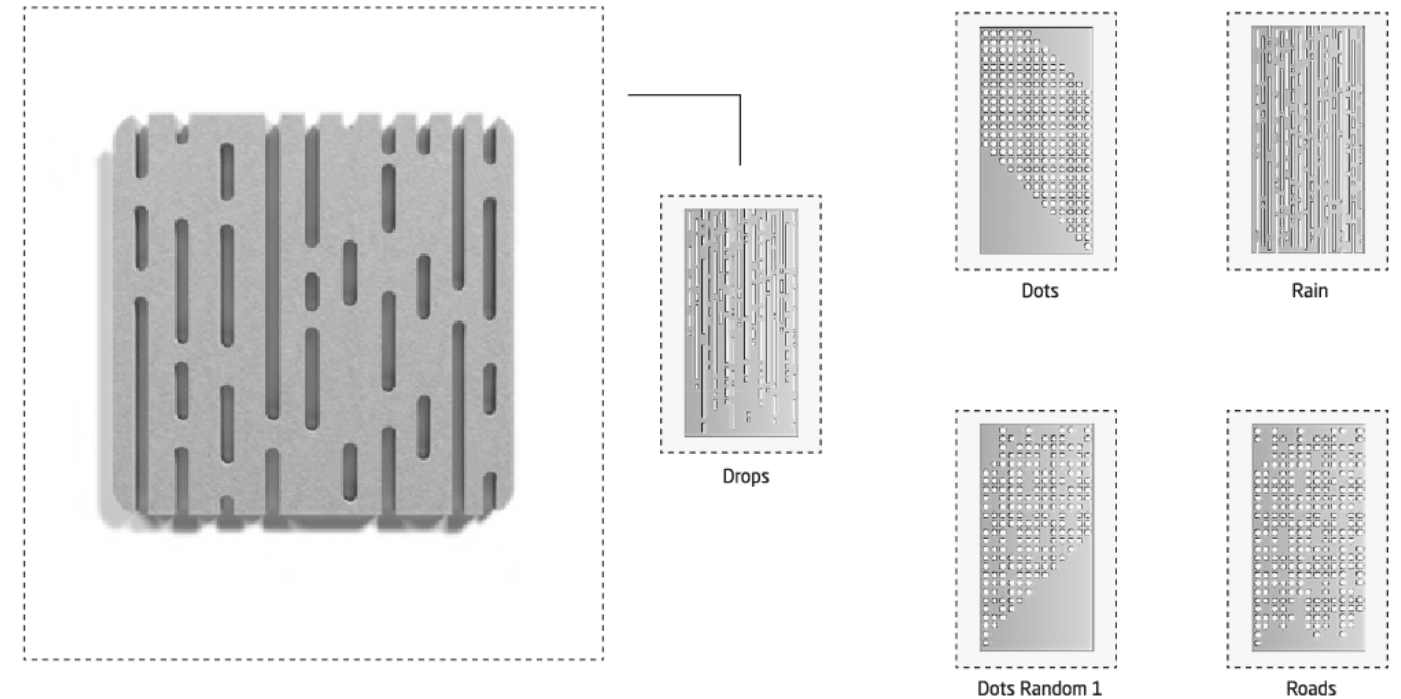

COLOR PALETTE

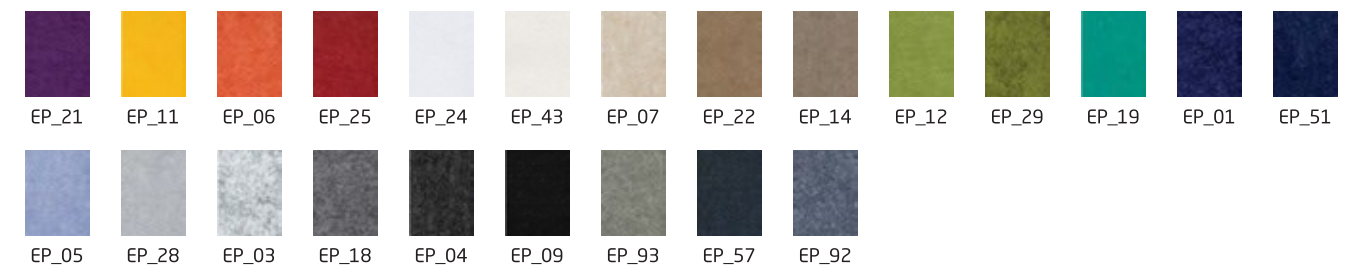

WOOD COLLECTION



INFORMATION

The hanging tiles series, grooved according to a pattern, that act as spaces dividers. They can be permanently hung or mobile on a rails.

PROPERTIES



Acoustic Absorption

Our products poses a superb acoustic quality: NRC=0.4-0.95 in a variety of implementation applications that enable the creation of an ideal living environment, pleasant and of high quality, well suited for office spaces, halls, education structures and entertainment places.

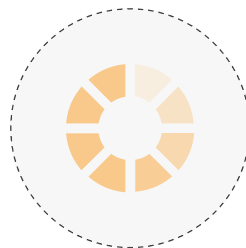

Color Fading

Assessment of colour fastness according to EN 1587 Assessed against the grey scale ISO 105-A02.

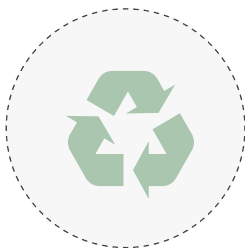

Recycled

The boards are made of 100% polyester PET, of which about 70% is recycled from drinking bottles.



Sustainability

Our PET Felt products contains post-consumer PET, does not contain any lead or tin, nor does it emit any (VOC) off gasses. It is recyclable and durable material, suitable for every environment.



Fire Reaction

Our products are manufactured in Israel according to the European fireproofing standard EN13501-I and American ASTM84 Class A.



Cleaning

Can be simply done using a damp cloth and vacuum cleaner.

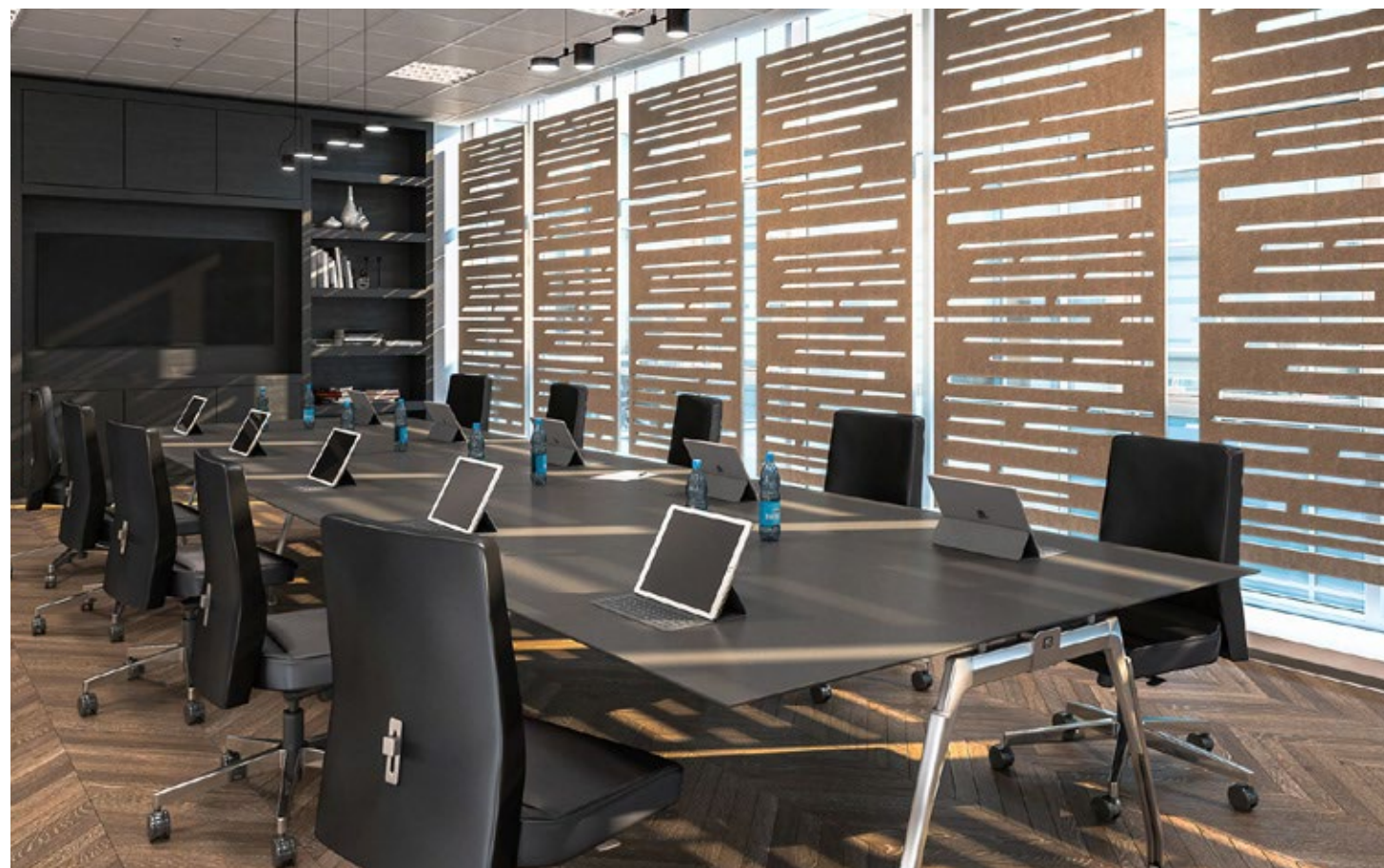

SPECIFICATION

PRODUCT	Width (mm)	Height (mm)	Thickness (mm)
Books	1200	2400	12
		2800	24

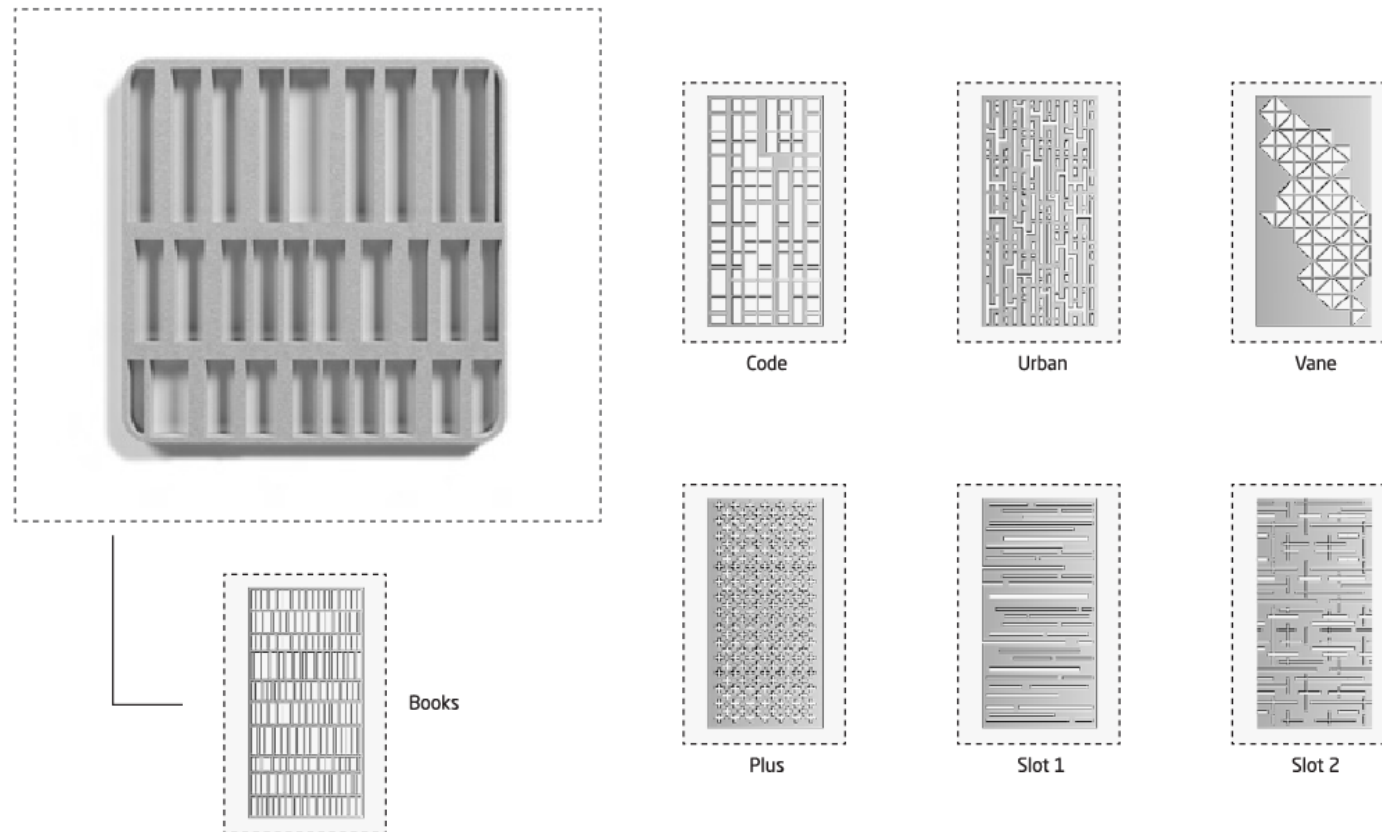

COLOR PALETTE

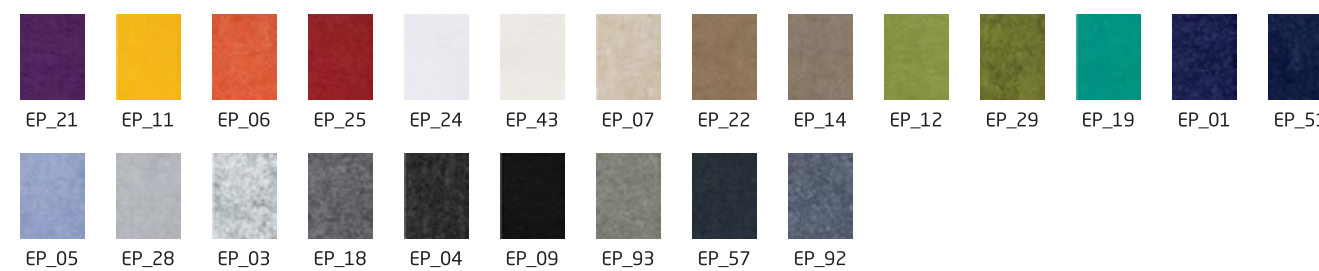

WOOD COLLECTION





Chapter

05

 **integra**[®]
FELTLINE CEILING SYSTEMS

Pyramid Tiles

- Vi
- Train
- Square

INFORMATION

A rectangular 3D tile, bent in an asymmetric cut. The tiles interlock with each other enabling the creation of diverse 3D assemblies for wall covering.

PROPERTIES



Acoustic Absorption

Our products poses a superb acoustic quality: NRC=0.4-0.95 in a variety of implementation applications that enable the creation of an ideal living environment, pleasant and of high quality, well suited for office spaces, halls, education structures and entertainment places.

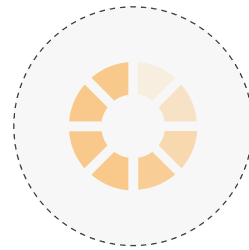

Color Fading

Assessment of colour fastness according to EN 1587 Assessed against the grey scale ISO 105-A02.

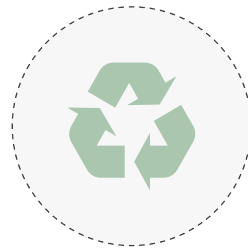

Recycled

The boards are made of 100% polyester PET, of which about 70% is recycled from drinking bottles.



Sustainability

Our PET Felt products contains post-consumer PET, does not contain any lead or tin, nor does it emit any (VOC) off gasses. It is recyclable and durable material, suitable for every environment.



Fire Reaction

Our products are manufactured in Israel according to the European fireproofing standard EN13501-I and American ASTM84 Class A.



Cleaning

Can be simply done using a damp cloth and vacuum cleaner.

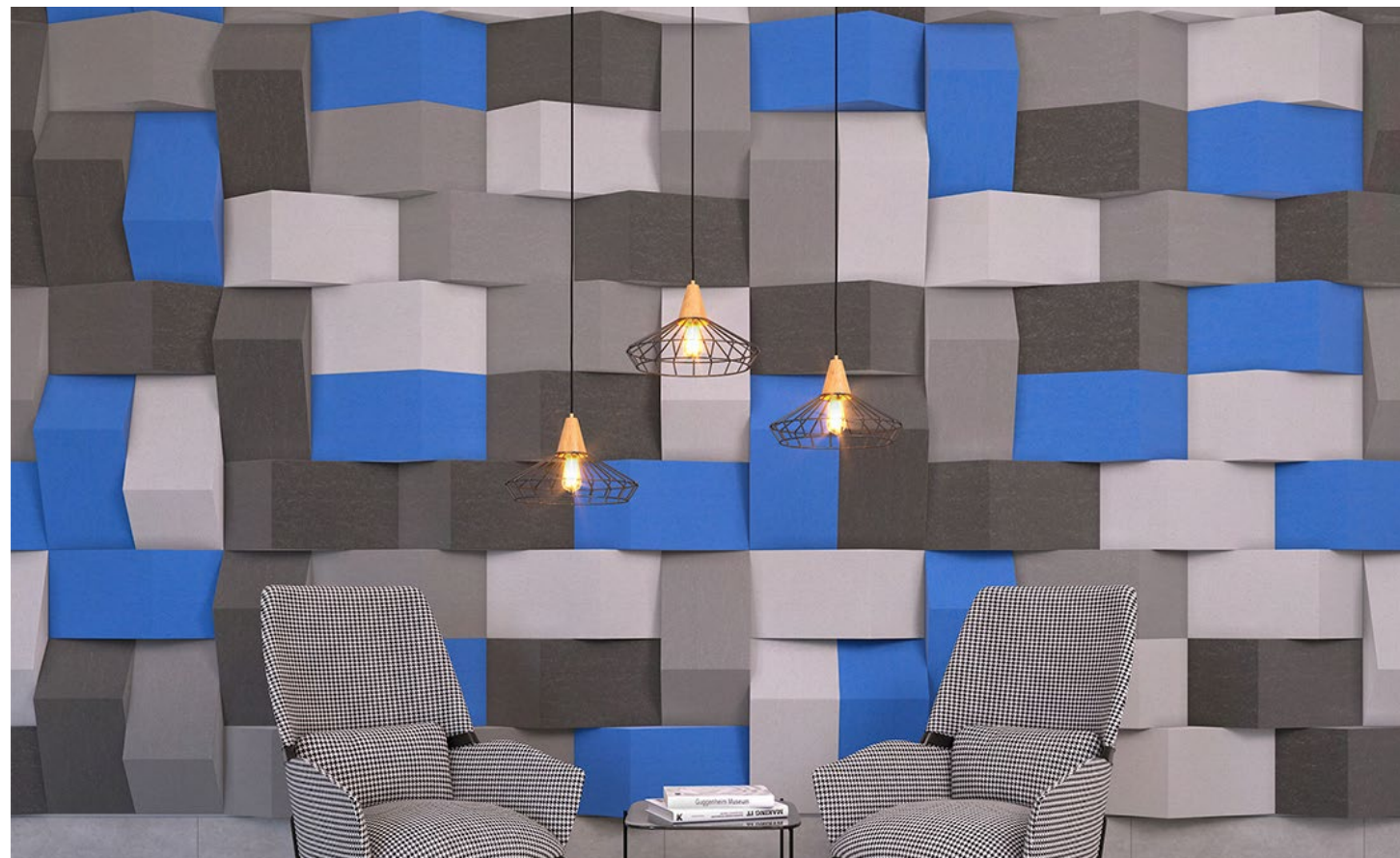

SPECIFICATION

PRODUCT	Length (mm)	Thickness (mm)
Vi	500x250x100	9
	600x300x100	

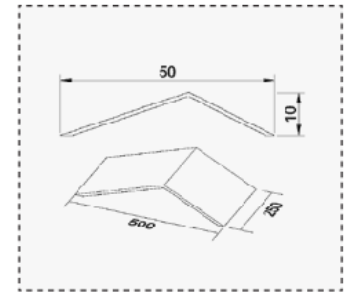

50x25x10 cm

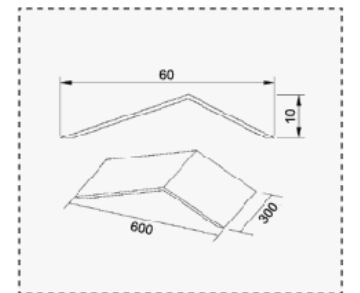

60x30x10 cm

COLOR PALETTE

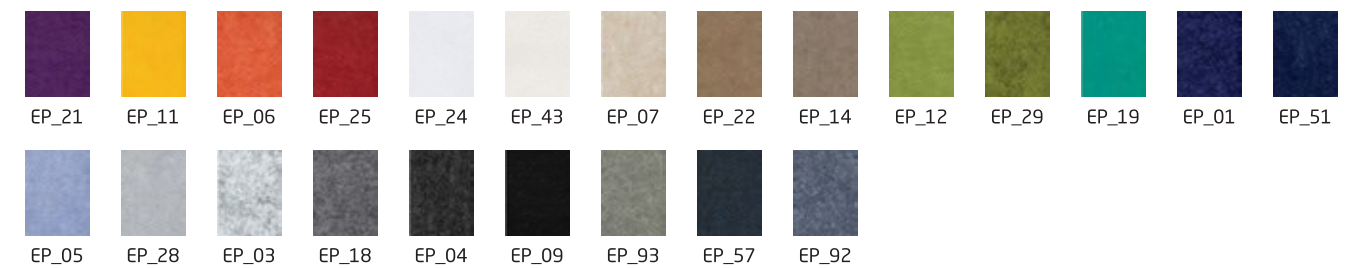

WOOD COLLECTION



INFORMATION

3D tile. A triangle pyramid, with an equilateral base. The tiles cling to each other - and together they create a three dimensional assembly for wall covering.

PROPERTIES



Acoustic Absorption

Our products poses a superb acoustic quality: NRC=0.4-0.95 in a variety of implementation applications that enable the creation of an ideal living environment, pleasant and of high quality, well suited for office spaces, halls, education structures and entertainment places.

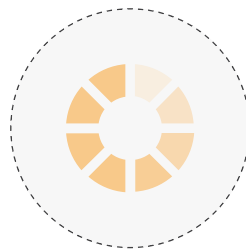

Color Fading

Assessment of colour fastness according to EN 1587 Assessed against the grey scale ISO 105-A02.

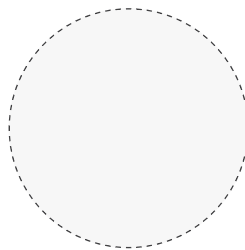

Recycled

The boards are made of 100% polyester PET, of which about 70% is recycled from drinking bottles.



Sustainability

Our PET Felt products contains post-consumer PET, does not contain any lead or tin, nor does it emit any (VOC) off gasses. It is recyclable and durable material, suitable for every environment.

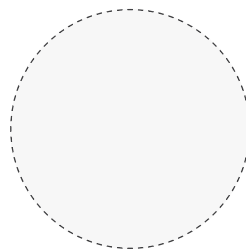

Fire Reaction

Our products are manufactured in Israel according to the European fireproofing standard EN13501-I and American ASTM84 Class A.



Cleaning

Can be simply done using a damp cloth and vacuum cleaner.



SPECIFICATION

PRODUCT	Length (mm)	Thickness (mm)
Train	300x300x100	9
	400x400x150	

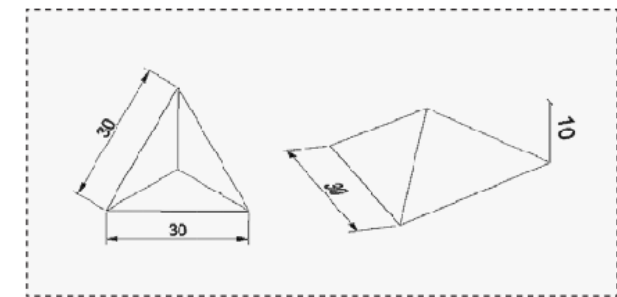
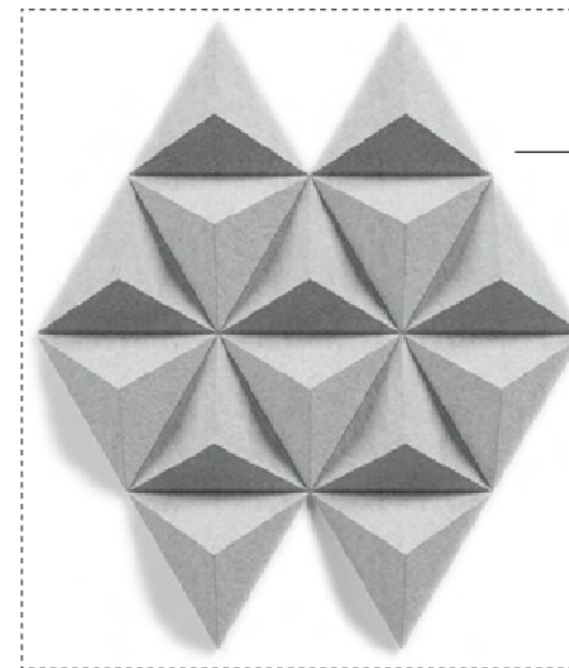

30x30x10 cm

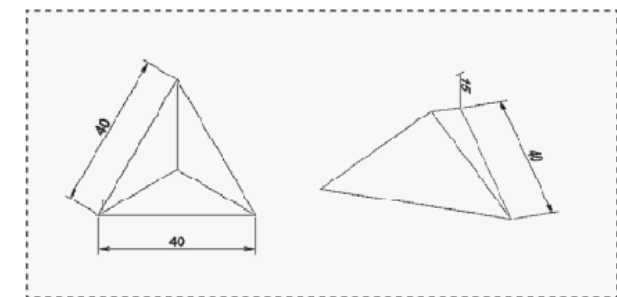

40x40x15 cm

COLOR PALETTE

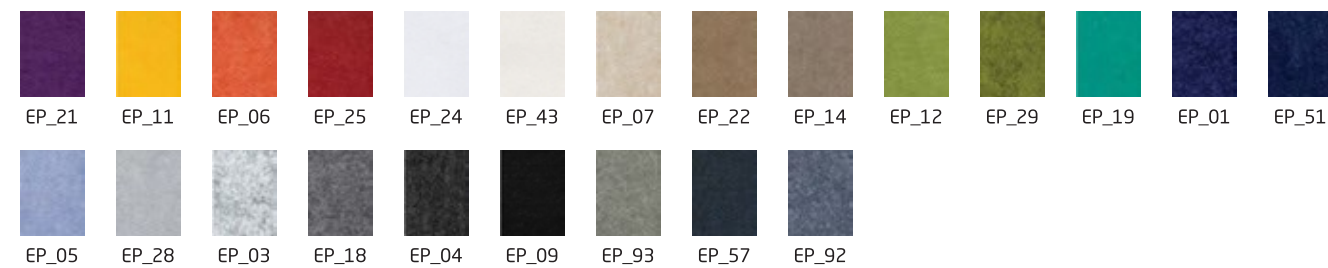

WOOD COLLECTION



INFORMATION

3D tile. A square pyramid, with an asymmetric apex. Equilateral base. The tiles cling to each other - and together they create a three dimensional assembly for wall covering.

PROPERTIES



Acoustic Absorption

Our products poses a superb acoustic quality: NRC=0.4-0.95 in a variety of implementation applications that enable the creation of an ideal living environment, pleasant and of high quality, well suited for office spaces, halls, education structures and entertainment places.

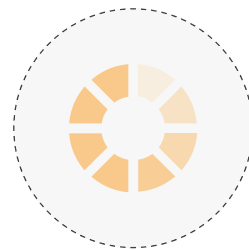

Color Fading

Assessment of colour fastness according to EN 1587 Assessed against the grey scale ISO 105-A02.

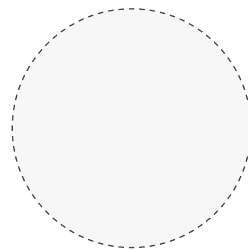

Recycled

The boards are made of 100% polyester PET, of which about 70% is recycled from drinking bottles.



Sustainability

Our PET Felt products contains post-consumer PET, does not contain any lead or tin, nor does it emit any (VOC) off gasses. It is recyclable and durable material, suitable for every environment.

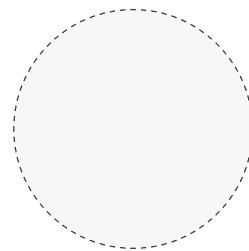

Fire Reaction

Our products are manufactured in Israel according to the European fireproofing standard EN13501-I and American ASTM84 Class A.



Cleaning

Can be simply done using a damp cloth and vacuum cleaner.

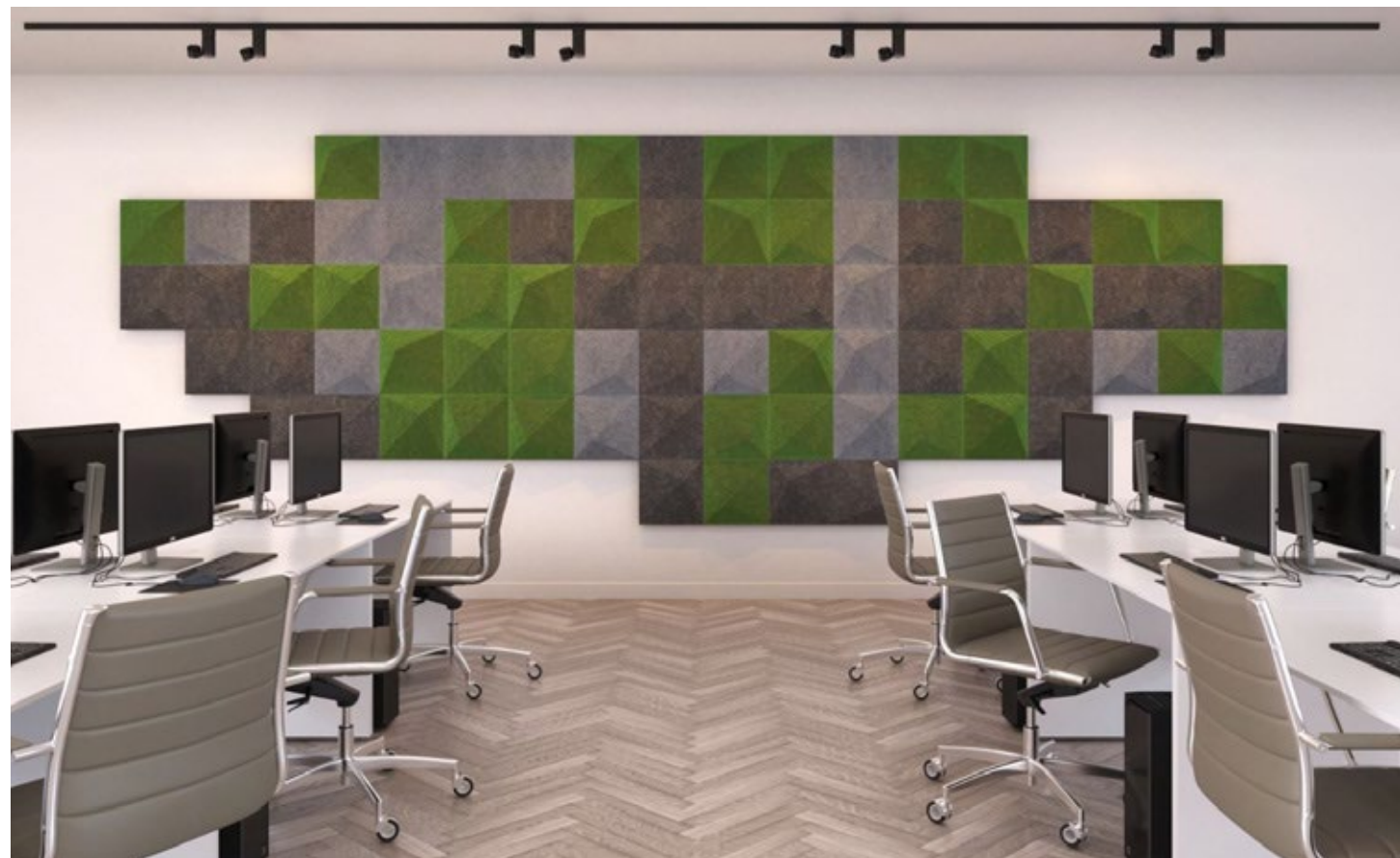

SPECIFICATION

PRODUCT	Length (mm)	Thickness (mm)
Square	350x350x50	9
	560x560x110	

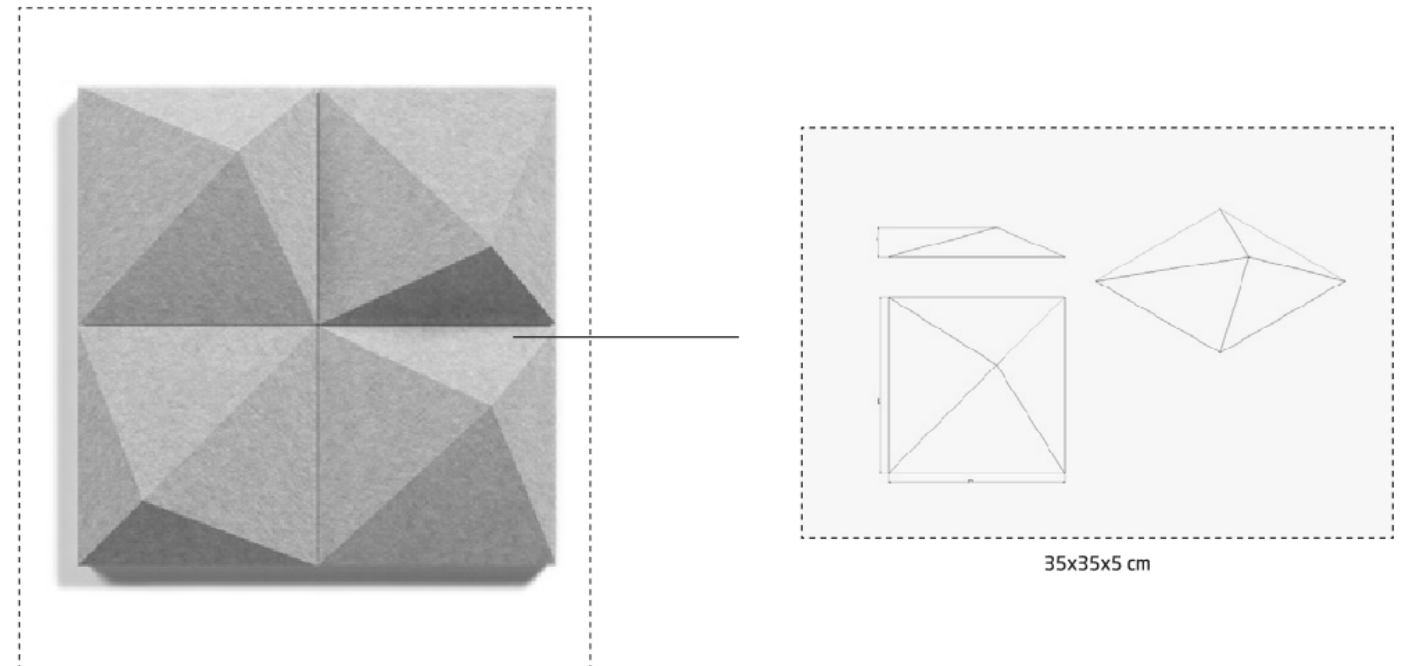

COLOR PALETTE

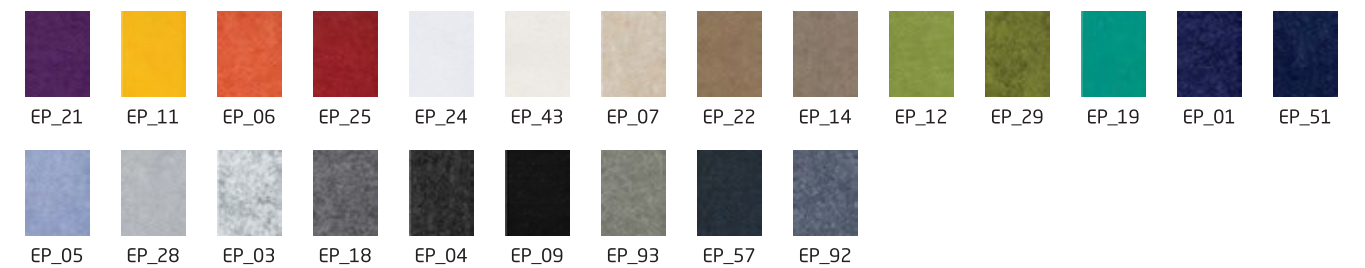

WOOD COLLECTION





Chapter

06

 **integra**[®]
FELTLINE CEILING SYSTEMS

Technical Information

- Color and Pattern
- Acoustics
- Fire



WOOD OPTIONS

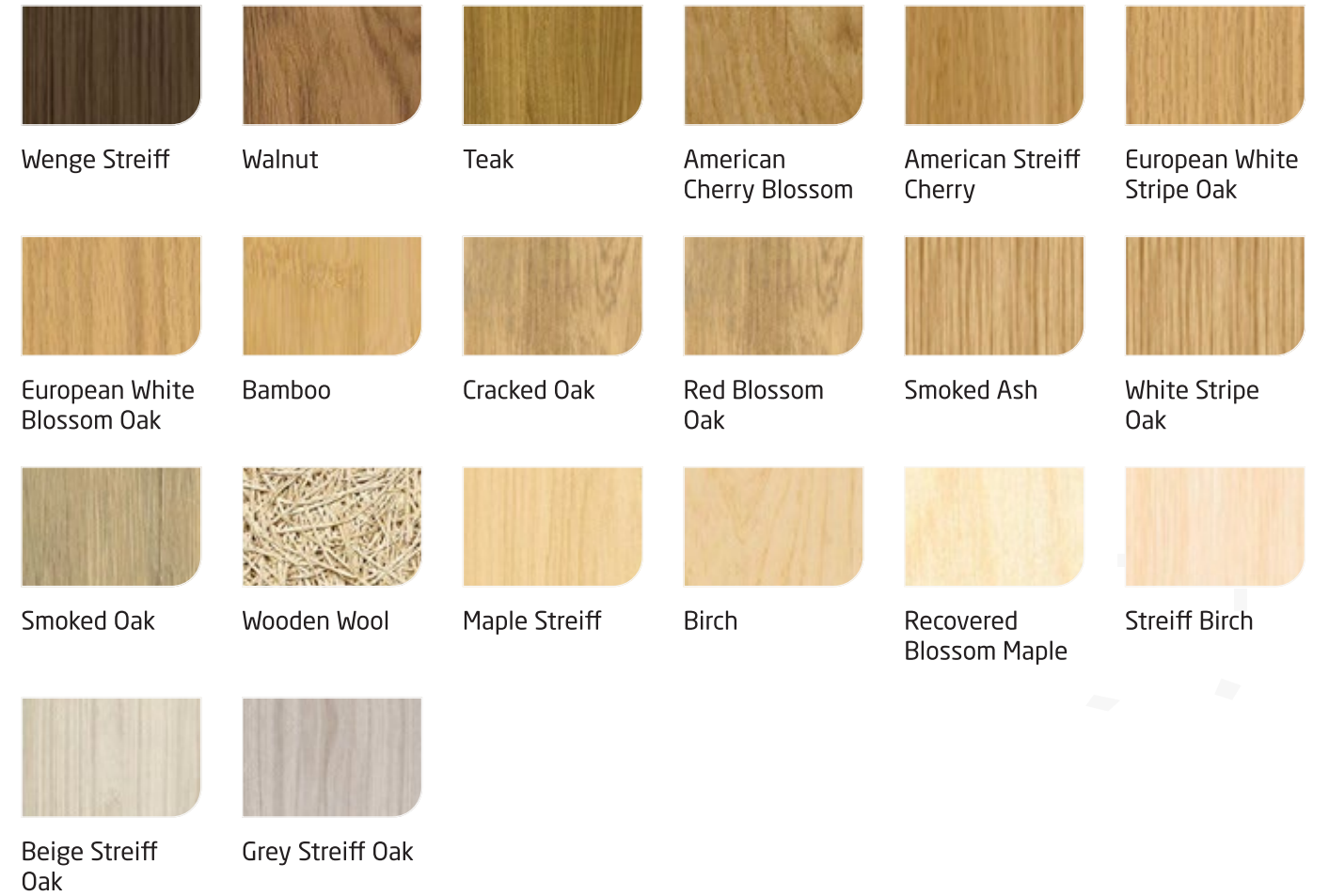

Wood color and pattern options are only for representation. All the available color and texture options can be different from what is shown in the catalogue. Integra has the right to make any amendments to the specifications of the products prior to informing. Please contact the sales department for all the available color and pattern options.

STANDART INTEGRA COLORS



Building acoustics can be reviewed under 3 main titles:

1) Indoor Acoustics

Associated with providing acoustic properties in enclosed spaces. While the most important evaluation criterion is reverberation time, "sound absorption" in the space is the key to achieving the acoustic values desired.

2) Sound Insulation

Associated with the feature of building and building conditions to prevent sound passing between two rooms. It can be divided into 2 types; providing sound insulation by air way and impact sound insulation in adjacent areas.

3) Noise

Associated with sounds in the outside environment such as vehicle noise, air conditioner, lighting equipment and background sounds or the human voice coming from the adjoining room.

SOUND ABSORPTION

When a sound wave hits any surface, part of its energy is reflected back into the room while the other part of it affects the surface. Part of the sound wave energy is converted into thermal energy and is absorbed while the remaining part is transmitted. The level of the energy converted into thermal energy is dependent on the sound absorption capacity of the panel. Integra metal ceiling panels, having been subjected to tests in international institutes and laboratories in accordance with DIN EN 20354 and DIN EN ISO 116554 norms, meet the Noise Reduction Coefficient values (NRC) required in the space. Sound absorption values are related directly to the material used and perforations applied on the panel. Perforated Metal Ceilings improve room acoustics and reduce the echo time.

SOUND INSULATION

Sound insulation is applied in order; to protect against the Hazardous and undesired effects of noise by insulating the living environment, to reduce the sounds emitted from noisy areas into the surrounding and to create suitable conditions of use in spaces such as movie theatres and recording studios.

Sound reduction values are generally subjected to testing according to EN ISO 140 and EN ISO 717-1 norms in the 1/3 octave band. The sound reduction value for acoustic applications in buildings is tested at frequencies ranging from 100 to 3150 Hz as per ISO and from 125 to 4000 Hz as per ASTM. The sound insulation value for ceilings according to the EN ISO 717-1 norms is defined as $D_{n,c,w}$ (dB). Integra metal ceiling panels sound insulation values can decrease sound transmissions arising from sound sources such as ventilation in the ceiling void, lighting systems and noise transmitted from room to room. **(20-40 dB)**

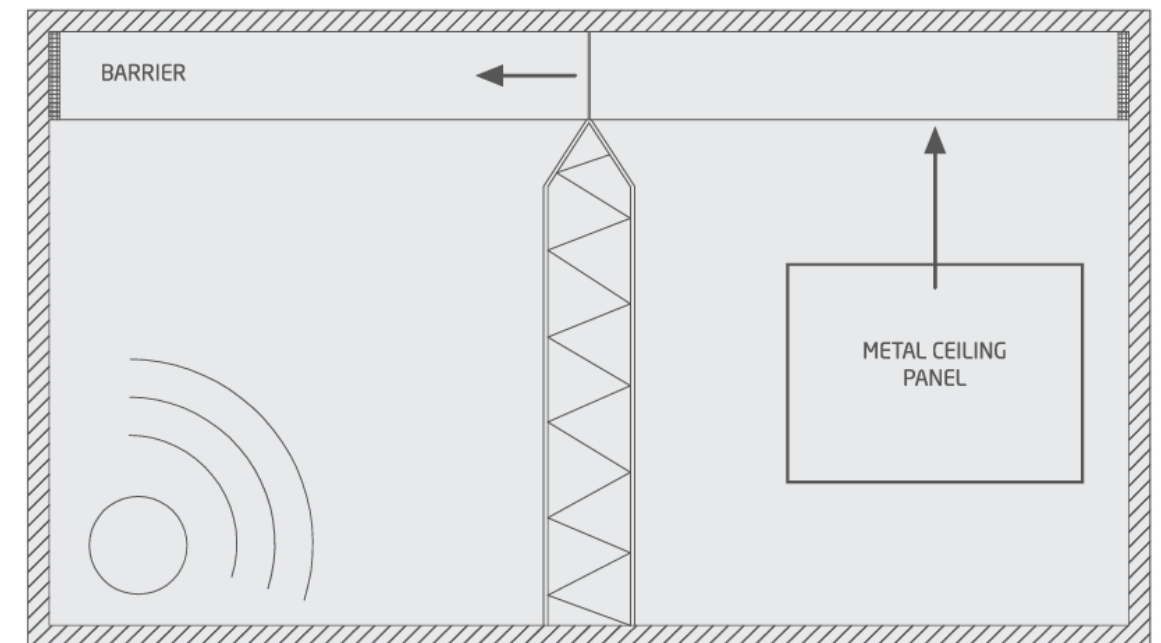
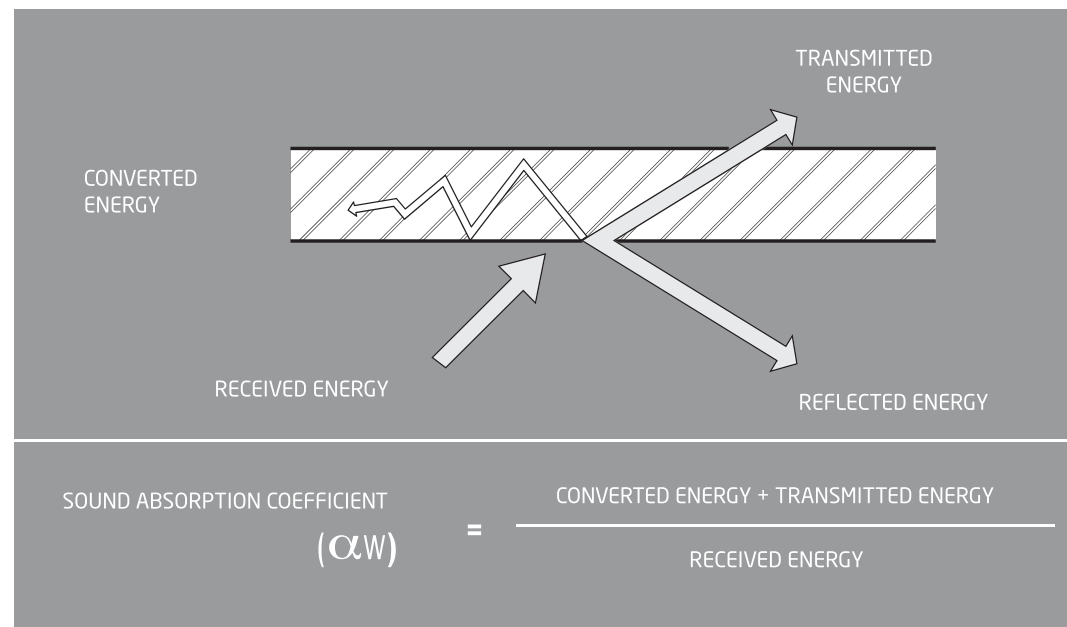

Tested Construction

The data presented here were taken from the information supplied by the principal. The density of the materials as reported is derived from the actual weighing by the laboratory staff of the materials under test.

The following wall panels have been tested.

Type: Echoshape
 Manufacturer: Beterplast
 Material: PET
 Panel sizes: 1200 mm x 400 mm
 Thickness: 9 mm
 Mass: 1,84 kg /m2 (weighted)



Type: Echoshape
 Manufacturer: Beterplast
 Material: PET
 Panel sizes: 1200 mm x 400 mm
 Thickness: 12 mm
 Mass: 2,33 kg/m2 (weighted)



Type: Echoshape
 Manufacturer: Beterplast
 Material: PET
 Panel sizes: 1200 mm x 600 mm
 Thickness: 24 mm
 Mass: 3,23 kg/m2 (weighted)



The results as presented here relate only to the tested items and laboratory conditions as described in this report. The laboratory can make no judgement about the representativity of the tested samples. The test report ahead is valid as long as the tested constructions and/or materials are unchanged.

Measurements

The wall panels are measured in the following measurement setups:

- 1. Airgap 0 mm:** The panels have been put directly on the floor of the reverberation room;
- 2. Airgap 50 mm:** The wall panels are mounted on a support structure at a distance of 50 mm above the floor of the reverberation room;
- 3. Airgap 200 mm:** The wall panels are mounted on a support structure at a distance of 200 mm above the floor of the reverberation room.

No suspension-system has been used, the panels were put tight to each other. The sides of the set-up were enclosed by 18 mm thick plastic covered chip wood board and sealed by tape. The measurement setups are according to type A and E mounting method as described in Annex B of ISO 354:2003 (Test specimen mountings for sound absorption tests).

Airgap of 0 mm

	sound absorption coefficient α_s					
Variant nr.	1	2	3			
Record nr.	#161	#124	#73			
Material thickness	9 mm	12 mm	24 mm			
See figure	3	4	5			
Frequency [Hz]	1/3 oct	1/1 oct	1/3 oct	1/1 oct	1/3 oct	1/1 oct
100	0,01		0,02		0,03	
125	0,00	0,01	0,01	0,02	0,03	0,05
160	0,03		0,03		0,09	
200	0,03		0,05		0,13	
250	0,04	0,05	0,05	0,07	0,19	0,21
315	0,07		0,11		0,31	
400	0,09		0,15		0,41	
500	0,13	0,13	0,20	0,21	0,49	0,51
630	0,18		0,29		0,63	
800	0,26		0,43		0,71	
1000	0,35	0,35	0,54	0,54	0,81	0,80
1250	0,45		0,65		0,88	
1600	0,55		0,76		0,95	
2000	0,65	0,65	0,83	0,83	0,98	0,97
2500	0,74		0,90		0,98	
3150	0,80		0,94		0,97	
4000	0,89	0,88	0,98	0,98	0,97	0,98
5000	0,95		1,02		1,00	
α_w	0,25 (H)		0,25 (H)		0,50 (H)	
SAA	0,30		0,41		0,62	

Airgap of 50 mm

	sound absorption coefficient α_s					
Variant nr.	4	5	6			
Record nr.	#419	#382	#345			
Material thickness	9 mm	12 mm	24 mm			
See figure	6	7	8			
Frequency [Hz]	1/3 oct	1/1 oct	1/3 oct	1/1 oct	1/3 oct	1/1 oct
100	0,00		0,02		0,04	
125	0,07	0,06	0,08	0,08	0,11	0,11
160	0,10		0,14		0,18	
200	0,15		0,20		0,26	
250	0,24	0,24	0,30	0,32	0,41	0,41
315	0,34		0,45		0,55	
400	0,48		0,58		0,68	
500	0,60	0,60	0,69	0,70	0,81	0,80
630	0,71		0,82		0,91	
800	0,84		0,91		0,97	
1000	0,91	0,92	0,93	0,95	0,99	0,98
1250	1,00		1,00		0,99	
1600	1,02		0,99		0,98	
2000	1,00	0,98	0,96	0,96	0,97	0,96
2500	0,93		0,92		0,94	
3150	0,87		0,90		0,97	
4000	0,88	0,91	0,95	0,95	0,98	0,99
5000	0,99		1,00		1,01	
α_w	0,55 (H)		0,60 (H)		0,70 (H)	
SAA	0,69		0,73		0,79	

Airgap of 200 mm

	sound absorption coefficient α_s					
Variant nr.	7	8	9			
Record nr.	#234	#271	#308			
Material thickness	9 mm	12 mm	24 mm			
See figure	9	10	11			
Frequency [Hz]	1/3 oct	1/1 oct	1/3 oct	1/1 oct	1/3 oct	1/1 oct
100	0,13		0,19		0,14	
125	0,35	0,34	0,42	0,40	0,37	0,36
160	0,53		0,60		0,56	
200	0,57		0,61		0,62	
250	0,74	0,70	0,75	0,74	0,82	0,79
315	0,79		0,87		0,94	
400	0,85		0,87		0,90	
500	0,87	0,87	0,89	0,88	0,93	0,90
630	0,88		0,88		0,87	
800	0,71		0,73		0,77	
1000	0,69	0,74	0,75	0,78	0,81	0,84
1250	0,82		0,87		0,94	
1600	0,86		0,88		0,93	
2000	0,85	0,87	0,91	0,92	0,96	0,96
2500	0,91		0,96		0,99	
3150	0,92		0,96		1,01	
4000	0,91	0,93	0,98	0,98	0,99	1,02
5000	0,96		1,01		1,05	
α_w	0,85 (H)		0,90 (H)		0,90 (H)	
SAA	0,80		0,83		0,87	

MEASUREMENT OF SOUND ABSORPTION IN A REVERBERATION ROOM ACCORDING TO ISO 354:2003

Variant 1: Echoshape, t = 9 mm, gap = 0 mm

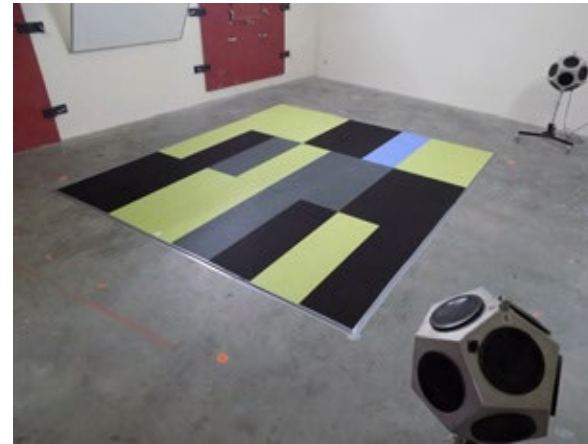
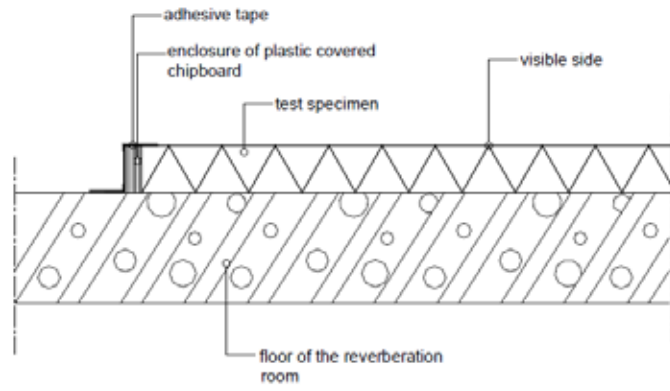

MEASUREMENT OF SOUND ABSORPTION IN A REVERBERATION ROOM ACCORDING TO ISO 354:2003

Variant 2: Echoshape, t = 12 mm, gap = 0 mm

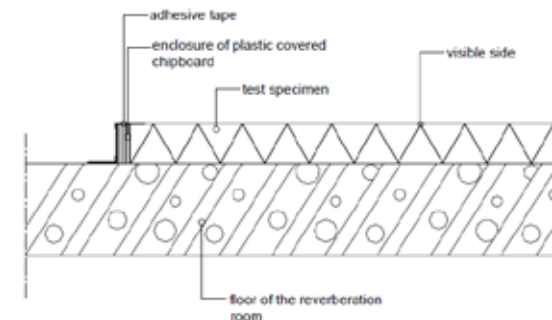

Volume reverberation room: 214 m³
 Surface area sample: 11,52 m²
 Height of the construction: 9 mm
 Measured at: Peutz Laboratory for Acoustics
 Signal: Broad-band noise
 Bandwidth: 1/3 octave

α_w (ISO 11654) = 0,25(H)
 SAA (ASTM - C423) = 0,30

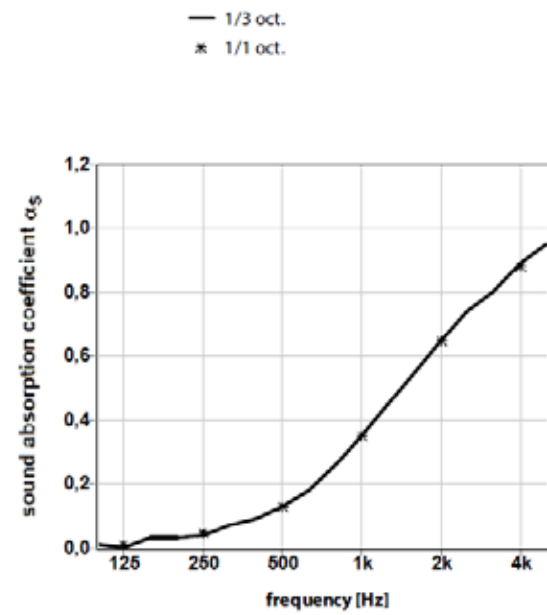

	0,01	0,03	0,09	0,26	0,55	0,80
1/3 oct.	0,00	0,04	0,13	0,35	0,65	0,89
	0,03	0,07	0,18	0,45	0,74	0,95
1/1 oct.	0,01	0,05	0,13	0,35	0,65	0,88

Volume reverberation room: 214 m³
 Surface area sample: 11,52 m²
 Height of the construction: 12 mm
 Measured at: Peutz Laboratory for Acoustics
 Signal: Broad-band noise
 Bandwidth: 1/3 octave

α_w (ISO 11654) = 0,25(H)
 SAA (ASTM - C423) = 0,41

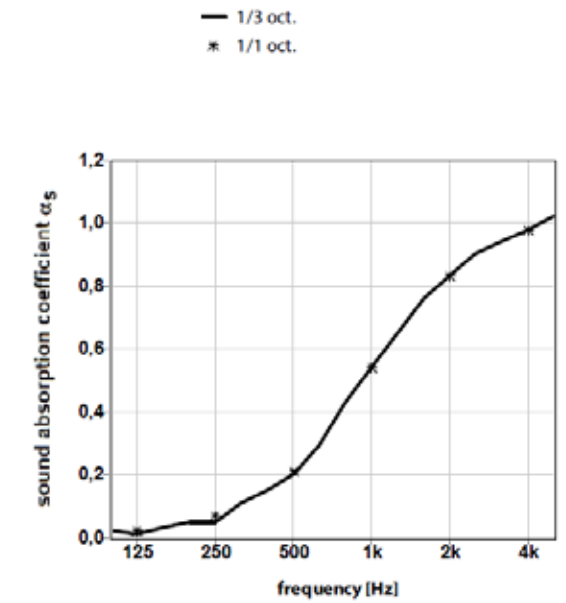

	0,02	0,05	0,15	0,43	0,76	0,94
1/3 oct.	0,01	0,05	0,20	0,54	0,83	0,98
	0,03	0,11	0,29	0,65	0,90	1,02
1/1 oct.	0,02	0,07	0,21	0,54	0,83	0,98

MEASUREMENT OF SOUND ABSORPTION IN A REVERBERATION ROOM ACCORDING TO ISO 354:2003

Variant 3: Echoshape, t = 24 mm, gap = 0 mm

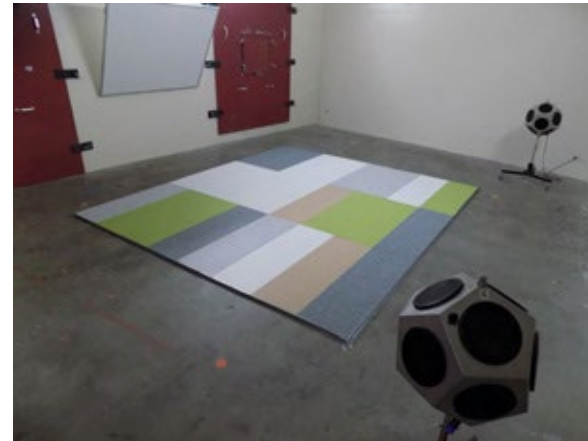
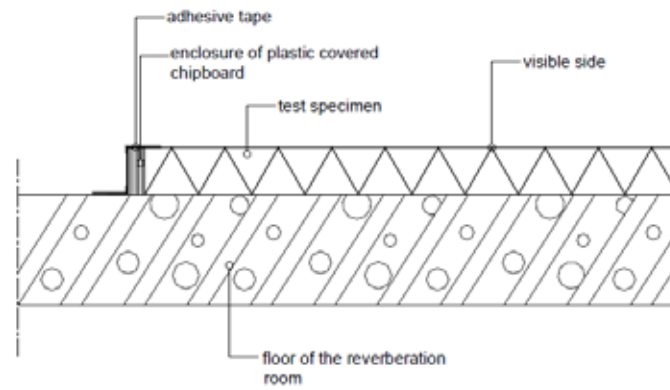

Volume reverberation room: 214 m³
 Surface area sample: 11,52 m²
 Height of the construction: 24 mm
 Measured at: Peutz Laboratory for Acoustics
 Signal: Broad-band noise
 Bandwidth: 1/3 octave

α_w (ISO 11654) = 0,25(H)
 SAA (ASTM - C423) = 0,62

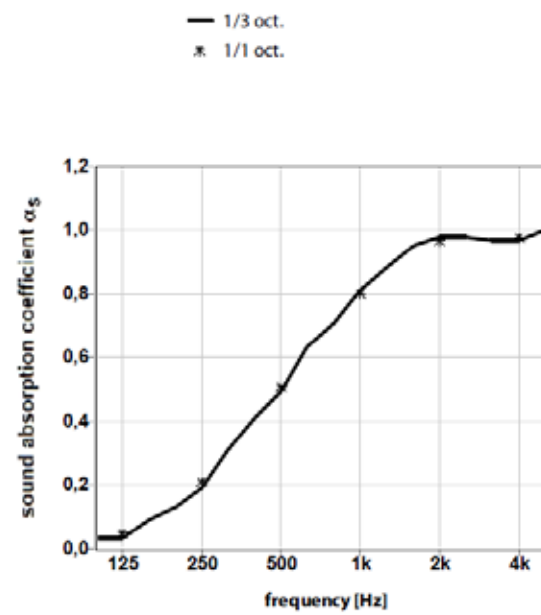

1/3 oct.	0,03	0,13	0,41	0,71	0,95	0,97
1/1 oct.	0,05	0,21	0,51	0,80	0,97	0,98

MEASUREMENT OF SOUND ABSORPTION IN A REVERBERATION ROOM ACCORDING TO ISO 354:2003

Variant 4: Echoshape, t = 9 mm, gap = 50 mm

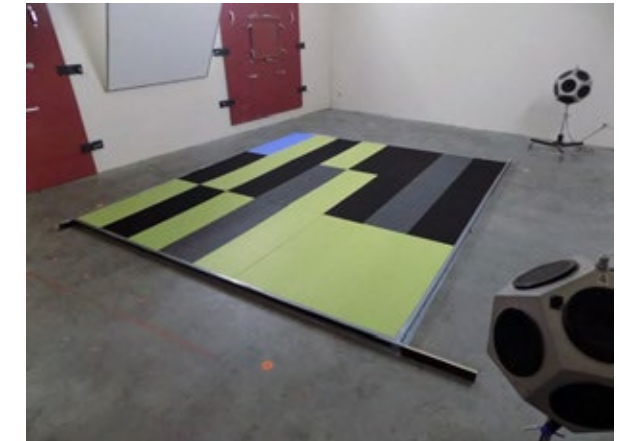
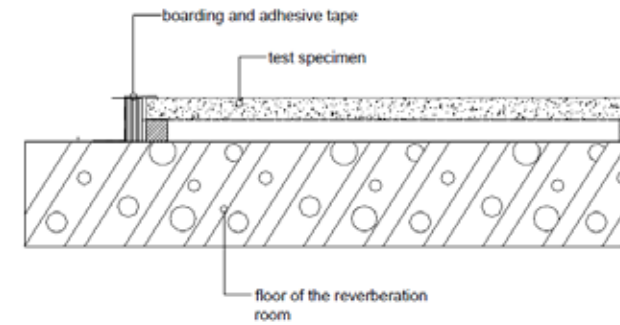

Volume reverberation room: 214 m³
 Surface area sample: 11,52 m²
 Height of the construction: 59 mm
 Measured at: Peutz Laboratory for Acoustics
 Signal: Broad-band noise
 Bandwidth: 1/3 octave

α_w (ISO 11654) = 0,55(H)
 SAA (ASTM - C423) = 0,69

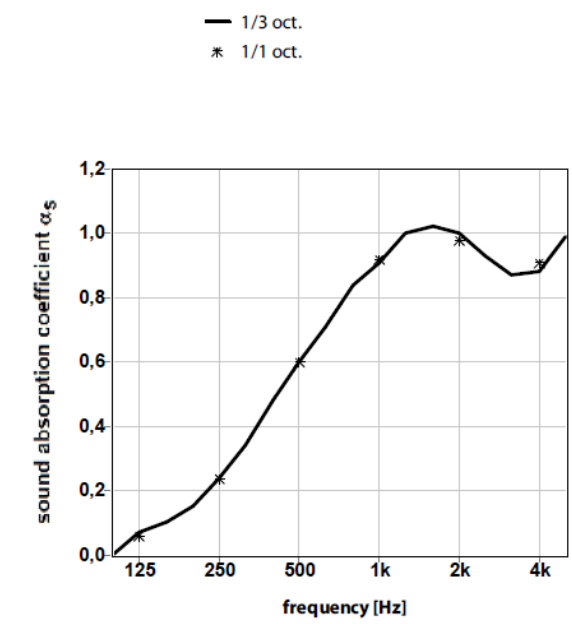

1/3 oct.	0,00	0,15	0,48	0,84	1,02	0,87
1/1 oct.	0,06	0,24	0,60	0,92	0,98	0,91

MEASUREMENT OF SOUND ABSORPTION IN A REVERBERATION ROOM ACCORDING TO ISO 354:2003

Variant 5: Echoshape, t = 12 mm, gap = 50 mm

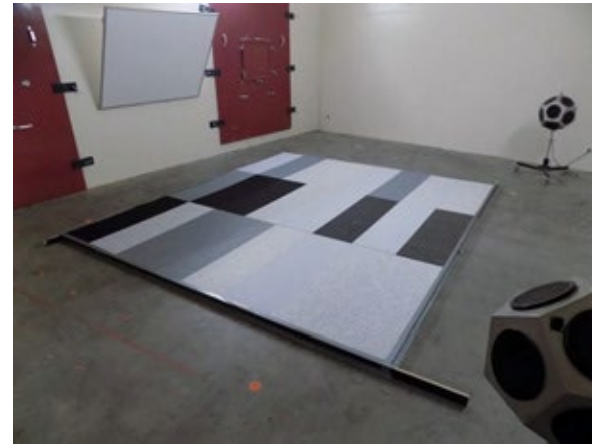
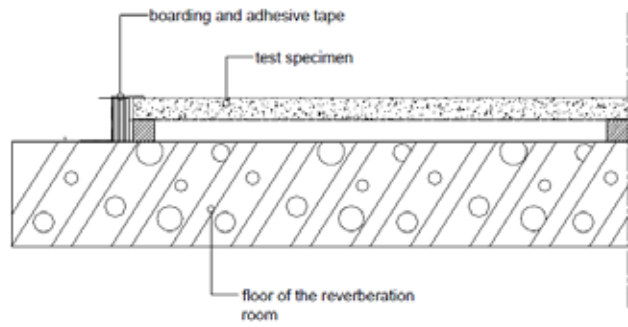

Volume reverberation room: 214 m³
 Surface area sample: 11,52 m²
 Height of the construction: 62 mm
 Measured at: Peutz Laboratory for Acoustics
 Signal: Broad-band noise
 Bandwidth: 1/3 octave

α_w (ISO 11654) = 0,60 (H)
 SAA (ASTM - C423) = 0,73

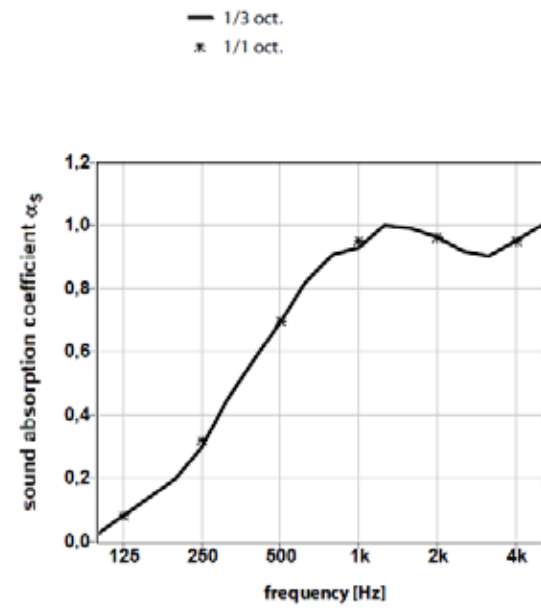

1/3 oct.	0,02	0,20	0,58	0,91	0,99	0,90
	0,08	0,30	0,69	0,93	0,96	0,95
	0,14	0,45	0,82	1,00	0,92	1,00
1/1 oct.	0,08	0,32	0,70	0,95	0,96	0,95

MEASUREMENT OF SOUND ABSORPTION IN A REVERBERATION ROOM ACCORDING TO ISO 354:2003

Variant 6: Echoshape, t = 24 mm, gap = 50 mm

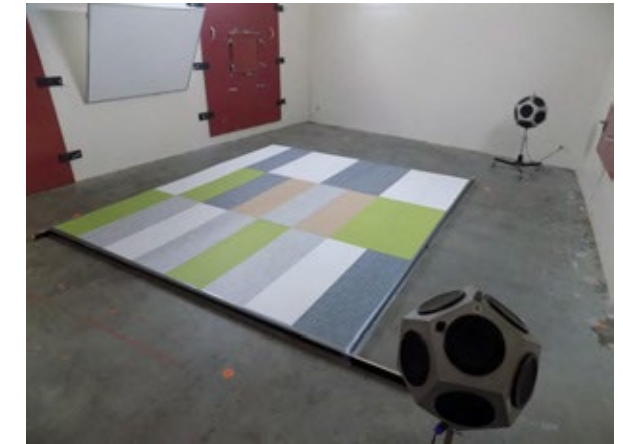
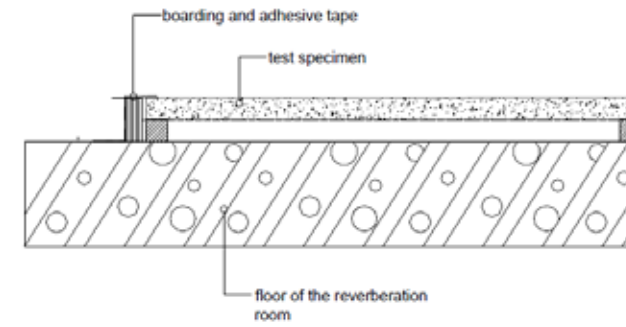

Volume reverberation room: 214 m³
 Surface area sample: 11,52 m²
 Height of the construction: 74 mm
 Measured at: Peutz Laboratory for Acoustics
 Signal: Broad-band noise
 Bandwidth: 1/3 octave

α_w (ISO 11654) = 0,70 (H)
 SAA (ASTM - C423) = 0,79

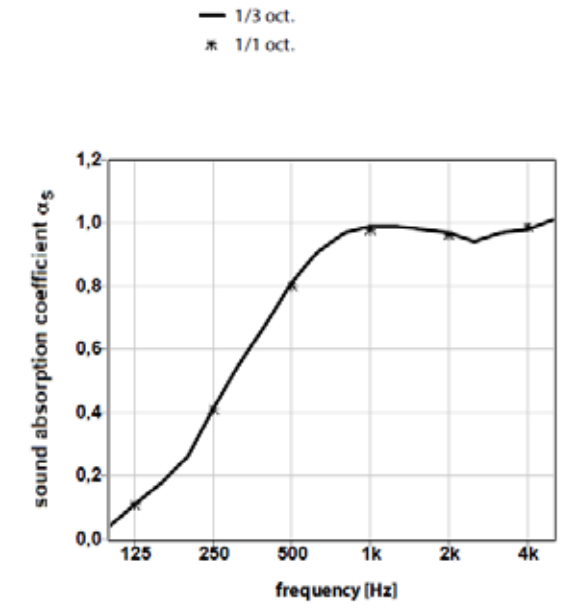

1/3 oct.	0,04	0,26	0,68	0,97	0,98	0,97
	0,11	0,41	0,81	0,99	0,97	0,98
	0,18	0,55	0,91	0,99	0,94	1,01
1/1 oct.	0,11	0,41	0,80	0,98	0,96	0,99

MEASUREMENT OF SOUND ABSORPTION IN A REVERBERATION ROOM ACCORDING TO ISO 354:2003

Variant 7: Echoshape, t = 9 mm, gap = 200 mm

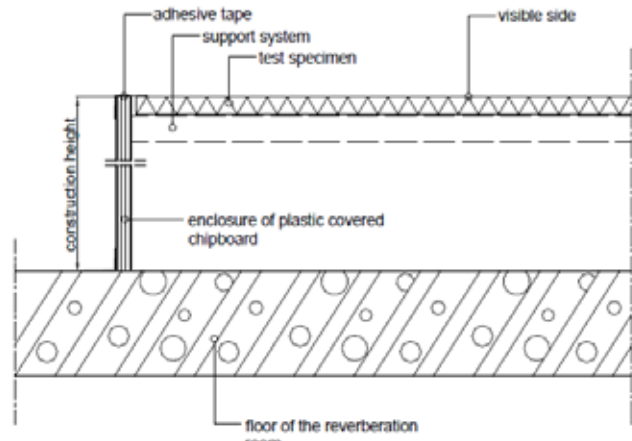

Volume reverberation room: 214 m³
 Surface area sample: 11,52 m²
 Height of the construction: 209 mm
 Measured at: Peutz Laboratory for Acoustics
 Signal: Broad-band noise
 Bandwidth: 1/3 octave

α_w (ISO 11654) = 0,85 (H)

SAA (ASTM - C423) = 0,80

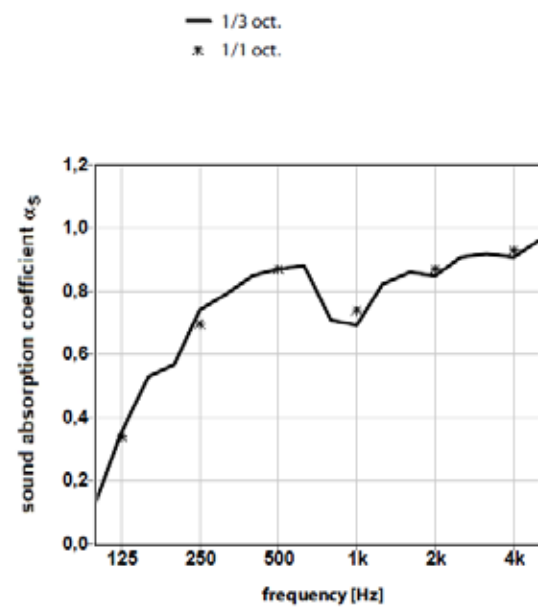

1/3 oct.	0,13	0,57	0,85	0,71	0,86	0,92
1/1 oct.	0,35	0,74	0,87	0,69	0,85	0,91
1/1 oct.	0,53	0,79	0,88	0,82	0,91	0,96
1/1 oct.	0,34	0,70	0,87	0,74	0,87	0,93

MEASUREMENT OF SOUND ABSORPTION IN A REVERBERATION ROOM ACCORDING TO ISO 354:2003

Variant 8: Echoshape, t = 12 mm, gap = 200 mm

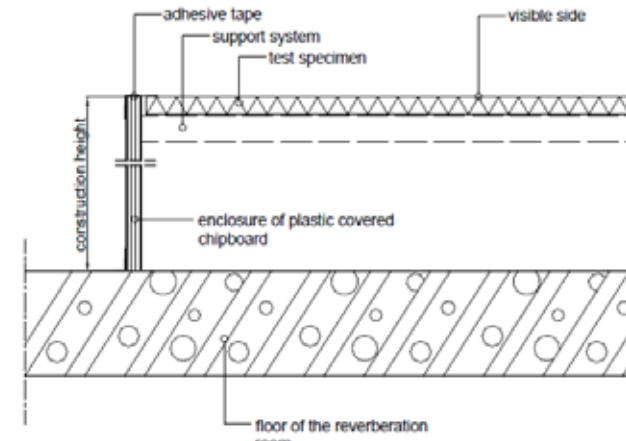

Volume reverberation room: 214 m³
 Surface area sample: 11,52 m²
 Height of the construction: 212 mm
 Measured at: Peutz Laboratory for Acoustics
 Signal: Broad-band noise
 Bandwidth: 1/3 octave

α_w (ISO 11654) = 0,90 (H)

SAA (ASTM - C423) = 0,83

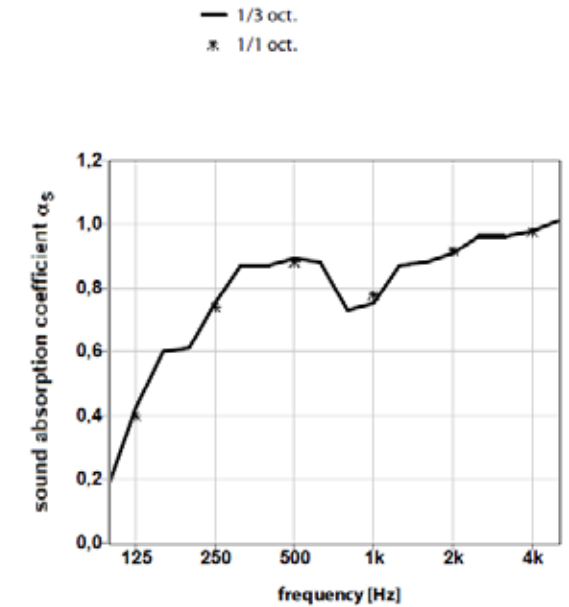

1/3 oct.	0,19	0,61	0,87	0,73	0,88	0,96
1/3 oct.	0,42	0,75	0,89	0,75	0,91	0,98
1/1 oct.	0,60	0,87	0,88	0,87	0,96	1,01
1/1 oct.	0,40	0,74	0,88	0,78	0,92	0,98

**MEASUREMENT OF SOUND ABSORPTION IN A REVERBERATION ROOM
ACCORDING TO ISO 354:2003**

Variant 9: Echoshape, t = 24 mm, gap = 200 mm

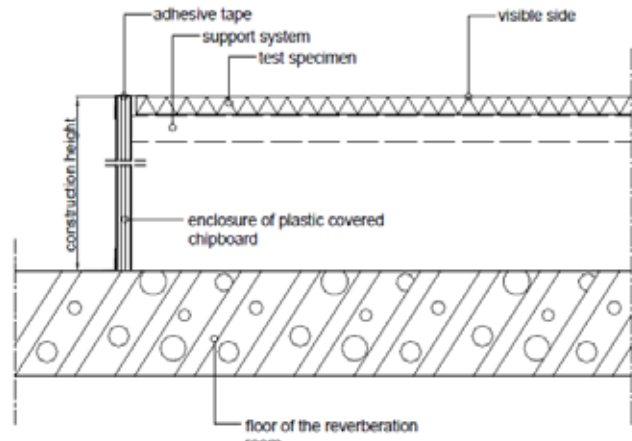

Volume reverberation room: 214 m³
 Surface area sample: 11,52 m²
 Height of the construction: 224 mm
 Measured at: Peutz Laboratory for Acoustics
 Signal: Broad-band noise
 Bandwidth: 1/3 octave

α_w (ISO 11654) = 0,90 (H)

SAA (ASTM - C423) = 0,87

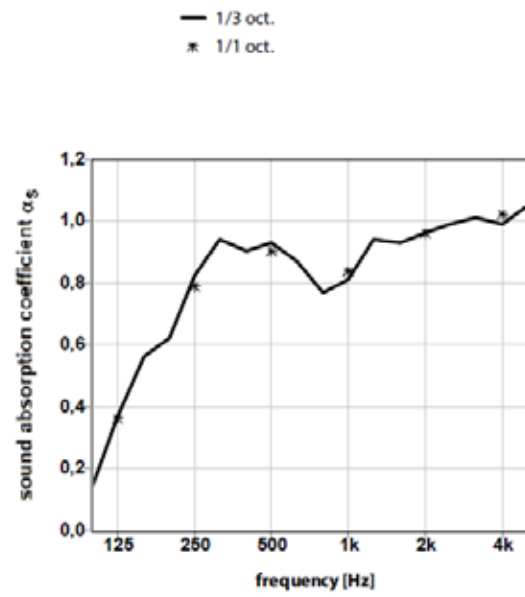

	0,14	0,62	0,90	0,77	0,93	1,01
1/3 oct.	0,37	0,82	0,93	0,81	0,96	0,99
	0,56	0,94	0,87	0,94	0,99	1,05
1/1 oct.	0,36	0,79	0,90	0,84	0,96	1,02

The main purpose of ensuring fire safety is to minimize the degree of destruction arising from an outbreak of fire. When providing fire safety, above all else, the type of building and room in which the suspended ceiling system to be installed is important. During the initial stages of a fire there are three critical conditions to be considered:

- Suspended ceilings should not contribute to the spread of the fire or the formation of smoke. This may be ensured by the use of suspended ceiling systems that conform to the Euro class B-s1 (s2) d0 class of reaction to fire.
- While rescue and evacuation operations are conducted during the early stages of the fire, suspended ceiling systems should not be demolished or collapse. This is possible with suspended ceiling systems capable of withstanding heat up to approximately 300°C.
- Suspended ceiling systems should not include any combustible materials.

Test and Classification

A2	s1	d0
Basic class	Smoke class formation	Flaming droplets

- Basic classes
A1, A2, B,C,D, E and F (A1; the best, F; the worst)
- Smoke formation classes
s1, s2, and s3 (s1; the best)
- Flaming droplet classes
d0, d1,d2, (d0; the best)

Fire reaction class- Euroclass (EN 13501-1) standard

A1		
A2-s1, d0	A2-s1, d1	A2-s1, d2
A2-s2, d0	A2-s2, d1	A2-s2, d2
A2-s3, d0	A2-s3, d1	A2-s3, d2
B-s1, d0	B-s1, d1	B-s1, d2
B-s2, d0	B-s2, d1	B-s2, d2
B-s3, d0	B-s3, d1	B-s3, d2
C-s1, d0	C-s1, d1	C-s1, d2
C-s2, d0	C-s2, d1	C-s2, d2
C-s3, d0	C-s3, d1	C-s3, d2
D-s1, d0	D-s1, d1	D-s1, d2
D-s2, d0	D-s2, d1	D-s2, d2
D-s3, d0	D-s3, d1	D-s3, d2
E		
E-d2		
F		

Fire Reaction Performance Classes for Building Materials Other Than Flooring

Inflammables Feature of the Material	No Smoke Formation	No Burning/ Dripping Particles	European Class as per TS EN 135011 Inflammables
Inflammables	X	X	A1
Hard-flammable	X	X	A2-s1, d0
Hard flaming	X	X	B, C-s1, d0
		X	A2-s2, d0 A2, B, C-s3, d0
	X		A2, B, C-s1, d1 A2, B, C-s1, d2
(minimum)			A2, B, C-s3, d2
Normal flaming		X	D-s1,d0 D-s2,d0 D-s3,d0 E
			D-s1,d2 D-s2,d2 D-s3,d2
(minimum)			E-d2
Easy-flaming			F

The results as presented here relate only to the tested items and laboratory conditions as described in this report. The laboratory can make no judgement about the representativity of the tested samples. The test report ahead is valid as long as the tested constructions and/or materials are unchanged.



 echoshape

 integra[®]
FELTLINE CEILING SYSTEMS

Rak 22, 1551 NA Westzaan

T +31 (0) 75 - 612 72 90
F +31 (0) 75 - 670 14 97
E info@integra-groep.com

INTEGRA-GROEP.COM

